

Not Transferable
Security Classification: Non-Security



बैंक नोट पेपर मिल इण्डिया प्रा. लिमिटेड
BANK NOTE PAPER MILL INDIA PVT LIMITED
JV of SPMCIL - A Govt. of India Enterprises & BRBNMPL - A Subsidiary of RBI

This Tender is being issued only to limited bidders and is not an open invitation to quote in tender. Participation in this tender is by invitation only and is limited to bidders for item, to whom invitation has been sent. Unsolicited offers are liable to be ignored

TENDER ENQUIRY FOR SUPPLY OF MECHANICAL ITEMS AT BNPM PLANT, MYSURU.

This tender document contains 35 Pages

Tender Enquiry No.	BNPM/LTE/70/2026-27
Tender issuing date	22.05.2026
Pre-bid meeting date & time	Not Applicable
Due date & time for bid submission	05.06.2026 @ 11.00 Hours
Due date & time for bid opening	05.06.2026 @ 11.30 Hours
Mode of bid submission	Online
Type of tender	Limited Tender Enquiry
Tender Processing Fee	Rs 250/- + Taxes
Details of contact person	Deputy General Manager (SCM) 0821-2401111/181/177

Registered & Corporate Office:

**Administrative Building
Gate 1, Paper Mill Compound
Note Mudran Nagar, Mysuru - 570 003
Telephone No. 0821 - 2401 111**

e-mail: scm.tender@bnpmindia.com

website: www.bnpmindia.com



List of Contents

Section I	Notice Inviting Tender	Enclosed
Section II	Terms and Conditions	Enclosed
Section III	Technical Specifications	Enclosed
Section IV	Quality Control Requirements	Enclosed
Section V	Declarations	
	Annexure - A	Enclosed
	Annexure -B	Enclosed
	Annexure - C	Enclosed
Section VI	Price Bid format	Enclosed



SECTION I – NOTICE INVITING TENDER

E-tenders are invited from eligible and qualified tenderers for supply of following goods:

Schedule No.	Brief Description of Goods / Services	Required Quantity (UoM)
1.	Supply of Mechanical Items (14 line items) as per technical specifications at BNPM, Mysore.	Ref Section III, List of requirements.

- Aspiring Bidders/Contractors who have not registered in e-tendering should register through the website E – Tendering (www.tenderwizard.com/BNP) for participating in the Online Tenders. The registration charges will be Rs. 500/- plus applicable taxes (per year) which needs to be paid through electronic mode only.
- For details, registration and e-payment, please visit e-tendering website www.tenderwizard.com/BNP or contact **KEONICS help desk at 080-40482000/08951906455.**
- The NIT Form with standard tender documents will be accessible in the e-Tendering website (viz www.tenderwizard.com/BNP).
- Class III Digital Signature Certificate (DSC) is mandatory to participate in e-Tenders. Participating bidders/Contractors have to make sure that they have the valid DSC. If not, they can procure from any of the firm as approved by CCA.
- The tenderer shall satisfy BNPMIPL that they are competent and authorized to submit tender and/or to enter into a legally binding contract with the BNPMIPL. To this effect, any person giving a tender shall render documentary evidence that his signature on the tender submitted by him is legally binding upon himself, his firm or company as the case may be.
- For those tenderers whose technical bids do not satisfy the eligibility criteria, their financial Bids will not be opened.
- In the event of any of the above-mentioned dates being declared as a holiday/ closed day for the purchase organization, the tenders will be sold / received / opened on the next working day at the appointed time.
- BNPM reserves the right to cancel the tender at any stage without assigning the reasons thereof.
- The tender documents are not transferable.
- Bid should signed by the competent authority / official authorised by the competent authority (board resolution or power of attorney or Authorisation letter on company letter head etc.)
- Against receipt of the following notification through email from tender wizard, bidder must resubmit the bid even if the bidder have already submitted the bid through tender wizard.

Notification: If you have already submitted the tender, then ensure that you re-submit the tender. Else, your bid may be liable to be auto disqualified by the system and service provider holds no responsibility for the same. In case, you are yet to submit the tender, then please ensure that you submit it before the tender closing time.

- Submission / resubmission of the bid is the responsibility of the bidders only. Bidder should check and confirm at their end regarding the submission/ resubmission of their bid till the due date & time of bid submission. BNPM/KEONICS/Tender wizard will not be responsible for non-submission/ non resubmission of any bid.

Yours faithfully,

For and on behalf of BNPMIPL

--sd--

Deputy General Manager



SECTION II - TERMS & CONDITIONS

1. Tenders are to be uploaded on e-tendering portal www.tenderwizard.com/BNP only in single stage, two bid system.
2. **Uploading of Bid:**
 - i. **Part-I - Prequalification Bid & Techno-commercial Bid:** Scanned copy of technical offer (catalogue/brochure etc.), Certificate of Incorporation/Partnership Deed (as applicable), GST, PAN, Bank details, Price Bid, acceptance to Terms & conditions and technical specification of tender etc., along with all sections & annexures of this tender shall be furnished through e-portal only.
 - ii. **Part II - Price Bid:** Price shall be furnished through e-portal in **.xlsm** format only. Price offer submitted in any other format/place will be liable for rejection.
3. **Payment terms:**
 - a) 100% amount of the total order value shall be released within 30 days on receipt and acceptance of complete ordered items by the consignee at destination (i.e. BNPM, Mysuru) and on production of all required documents by the supplier.
 - b) Payment will be released only if the supplied consignment meets the specifications & quality criteria mentioned in the Technical Specifications.
4. **Delivery Schedule:** Successful bidder shall complete supply of goods within **14 Weeks (Ref Section III- Required delivery schedule)** from date of placement of purchaser order.
5. **Liquidated Damages: Liquidated Damages:** In case your quotation is accepted and order is placed on you, the supply against the order should be made within the period stipulated in the order. BNPMIPL reserves the right to recover any loss sustained due to delayed delivery by way of liquidated damages. Failure to supply the material within the stipulated period shall entitle BNPM to impose liquidated damages without assigning any reasons @ 0.5% (Half Percent) of the delivered price of the delayed Goods for each week of delay or part thereof until actual delivery subject to a maximum deduction of 5% (Five Percent) of the total contract value which you unconditionally and expressly agree to unless extension is obtained from BNPM without imposition of LD, without price escalation along with any other denial conditions (if applicable) on valid ground before expiry of delivery period. In case of inordinate delay (Inexcusable delays of more than one-fourth (25%) of the total completion period shall be treated as inordinate delays) this maximum deduction shall be 10% of the total contract value.
6. **Warranty:** Not applicable.
7. Manufacturer's name and country of origin of materials offered must be clearly specified. Please quote whether your organization is large scale industry or small-scale industry. If you are registered with NSIC/MSE/MSI/DGS&D Certificate, please attach UDYAM certificate to the quotation. Mention your registration details.
8. Complete details and BIS/IS specification (if any) for the offered product must accompany the quotation. Make/brand of the item shall be stated wherever applicable. If you have got any deviation to the material required as per tender, the same may be shown separately at appropriate place provided in this document. Acceptance of deviation shall be at sole discretion of BNPM.
9. The prices quoted should be fixed & firm till the supplies are completed. Please quote the rates



SECTION II - TERMS & CONDITIONS

in words and figures. Rates quoted should be door deliver basis at destination including all charges otherwise the quotation is likely to be rejected. Price quoted should be net and valid for **a minimum period of 90 (Ninety) days** from the date of opening of the quotation.

10. Evaluation Criteria:

- (i) The technical bids shall be opened in the first instance and these bids shall be scrutinized and evaluated by the competent committee/ authority with reference to the parameters prescribed in the tender document. Subsequently, in the second stage the financial bids of only technically acceptable offers as decided in first stage shall be opened for further scrutiny and evaluation. Intimation regarding opening of financial bids shall be given to acceptable tenderers to enable them to attend the financial bid opening, if they so desire.
- (ii) **Method of Evaluation:** Evaluation shall be carried out on **Schedule wise lowest effective price** quoted by the bidders, unless any other method of evaluation is specifically provided in the enquiry and contract shall be awarded to **Schedule wise lowest (L-1) bidder** The quoted price should be inclusive of P&F, Freight, Transit Insurance and any other charges required for delivery of item to BNPM, Mysuru on F.O.R basis.
- (iii) **Price Tie:** In case of a price tie at L-1 price for two or more bidders, after application of purchase preference (against claim of purchase preference by bidder in techno commercial bid with applicable NIC) if it is observed that one of the L1 bidder is MSE, then an order shall be placed on such MSE bidder.

In all other scenarios, the order shall be placed on the L1 bidder having a higher turnover in the previous financial year. In case there is a tie at the lowest bid (L-1) position between only startup bidders and none of them has past turnover, the order will be placed on the startup that was registered earlier with the department of industrial promotion and policy.

- (iv) All responsive tenderers shall be evaluated as per the terms & conditions of the tender. The basis for arriving at the lowest responsive bidder shall be as per the price quoted for landed cost at Mysuru including GST, packing & forwarding charges, freight, insurance and any other charges etc. and input credit shall be deducted to arrive at the effective price. Effective price shall be considered for arriving the lowest responsive bidder.
- (v) Bidder has to mention appropriate HSN code and quote GST rate provided in Price Schedule. In case of any mismatch in HSN code with respect to offered product, same shall be decided in consultation with winning bidder
- (vi) All tenderers should be registered under GST. They should be eligible to pass on input credit. Bid will be evaluated all-inclusive though input credit will be deducted to arrive at the effective cost.

1. The evaluation of tender for three categories of GST registration is provided below:

Particulars	Registered	Composite	Unregistered*
Basic Price	xxx	xxx	xxx
Add: GST	X	-	X
Add: Cess on GST	xx	-	Xx
Less Input Credit	X	-	X
Total price	Xxx + X + xx - X	xxx	xxx + X + xx - X

*If the bidders participated in a tender is unregistered, the GST shall be payable by the purchaser under reverse charge and shall be added to the quoted rate to arrive at the Gross price and input credit, if any shall be deducted from the total landed cost to arrive at the net comparable price.



SECTION II - TERMS & CONDITIONS

11. Payment of GST is primarily the responsibility of the seller and will not be paid unless the percentage value is clearly mentioned in the quotations. If no indication regarding GST is recorded in the quotation, the GST will be considered as included. All statutory deduction as applicable shall be deducted at source as per rules at prevailing rates, unless certificate, if any, for deduction at lesser rate or nil deduction is submitted by the Successful bidder from appropriate authority. The successful bidder shall provide accurate particulars of PAN number as required, under Section 206AA of Income Tax Act 1961. TDS against GST & Income tax as per respective acts shall be deducted.

12. **Delay in supplier's performance/ Non-performance:** Time for and the date specified in the contract or as extended for the delivery of the stores shall be deemed to be the essence of the contract and the supplier shall deliver the goods and perform the services under the contract within the time schedule specified by BNPM in the contract.

Any delay attributable to the supplier in maintaining its contractual obligations towards delivery of goods and performance of services as well as non-performance shall render the supplier liable to any or all the following sanctions besides any administrative action such as (a) Imposition of liquidity damages; (b) Termination of contract for default; (c) Debarment.

13. **Extension of Time:** If the contract is delayed in the progress of work by changes ordered in the contract, or any clause which BNPM shall decide to justify the delay, then the time of completion shall be extended by a reasonable time.

If at any time during the currency of contract, the supplier encounters conditions hindering timely delivery of the goods and performance of services, the supplier shall promptly inform BNPM in writing about the same and its likely duration and make a request to BNPM for extension of the delivery schedule accordingly. On receiving the supplier's communication, BNPM shall examine the situation as soon as possible and, at its discretion, may agree to extend the delivery schedule, with or without liquidated damages for completion of supplier's contractual obligations by issuing an amendment to the contract.

14. **Risk Purchase Clause:** If the supplier fails to abide by the terms and conditions of the agreement arising out of this enquiry (or) fails to supply the material/service as per the delivery schedule or any time repudiates the contract, the purchaser will have the right to,

- a) Procure the tender item/render service from other agencies at the risk and cost of the supplier. The cost difference between the alternative arrangement and existing contract value where the default has been made, will be recovered from the supplier along with the other incidental charges.
- b) In case of procurement through alternative sources, if procurement price is lower than the existing contract value wherein default has been made, in such case no benefit on this account will be passed on to the supplier.

15. **Force Majeure:** In the event of any unforeseen event directly interfering with the supply of stores arising during the currency of the contract, such as war, hostilities, acts of the public enemy, civil commotion, sabotage, fires, floods, explosions, epidemics, quarantine restrictions, strikes, lockouts, or acts of God, the Contractor shall, within a week from the commencement thereof, notify the same in writing to the Purchaser with reasonable evidence thereof. Unless otherwise directed by BNPM in writing, the supplier shall continue to perform its obligations under the contract as far as reasonably practical, and shall seek all reasonable alternative means for performance not prevented by the Force Majeure event. If the force



SECTION II - TERMS & CONDITIONS

majeure condition(s) mentioned above be in force for a period of 90 days or more at any time, either party shall have the option to terminate the contract on expiry of 90 days of commencement of such force majeure by giving 14 days' notice to the other party in writing. In case of such termination, no damages shall be claimed by either party against the other, save and except those which had occurred under any other clause of this contract prior to such termination.

16. Fore-Closure Clause: If at any time during the continuation of this contract, the use of material ordered in this contract is completely banned or due to drastic change in Government policy its use as, raw material is discontinued or is declared hazardous to public health or cause rising to civil commotion, epidemics, wide-spread strikes and 21 days' notice of such eventualities is given by purchaser to the seller, the seller without any right to enforce the contract, will agree to the fore-close the performance of balance portion of this contract and in that event no claim for damages or loss will be lodged against the purchaser.

17. Obligations by bidders:

All bidders are obliged under the CIPP (Code of integrity of public procurement) to suo moto proactively declare any conflict of interest (coming under the definition as mentioned in conflict-of-interest clause below, pre-existing or as and as soon as these arise at any stage) in any procurement process or execution of contract. Failure to do so would amount to violation of this Code of Integrity; and

Any bidder must declare, whether asked or not in a bid document, any previous transgressions of such a Code of Integrity with any entity in any country during the last 3 (three) year or of being debarred by any other Procuring Entity. Failure to do so would amount to violation of this code of integrity.

18. Conflict of Interest: Bidders having a conflict of interest shall not be eligible to participate in the tender process unless the conflict stemming from such relationship has been resolved in a manner acceptable to BNPM throughout the Tender process and execution of the Contract (Code of Integrity for Public Procurement). The bidder shall be considered to have a conflict of interest in this tender process and execution of the resultant contract in the following situations:

- a. If its personnel have a close personal, financial, or business relationship with any personnel of the procuring entity who are directly or indirectly related to the procurement or execution process of the contract, which can affect the decision of the procuring entity directly or indirectly;
- b. The bidder (or his allied firm as defined by DOE, MOF, GOI) provided services for the need assessment/procurement planning of the Tender process in which it is participating;
- c. A Principal can authorize only one agent, and an agent should not represent or quote on behalf of more than one Principal. However, this shall not debar more than one Authorized distributor (with/ or without the OEM) from quoting equipment manufactured by an Original Equipment Manufacturer (OEM) in procurements under Proprietary Article Certificate or
- d. A bidder participates in more than one bid in this tender process. Participation in any capacity by a Bidder (including the participation of a Bidder as a partner/ JV member or sub-contractor in another bid or vice-versa) in more than one bid shall result in the disqualification of all bids in which he is a party. However, this does not limit the participation of an entity as a sub-contractor in more than one bid if he is not bidding



SECTION II – TERMS & CONDITIONS

independently in his own name or as a member of a JV.

19. Counter conditions (if any on technical & commercial terms) shall be reviewed by BNPM and acceptance of the same shall be at sole discretion of BNPM.
20. Bidders are advised to write the page number on each page of the Technical Bid documents submitted.
21. The BNPMIPL reserves the right to accept the offer by individual items and reject any or all tenders without assigning any reason thereof and does not bind itself to accept lowest quotations.
22. **Divisibility & split-ability of contract:** The tender is **non-divisible & non-split table**

23. **Settlement of Disputes through Arbitration:** All disputes and differences of any kind whatsoever arising out of or in connection with the contract, whether during the progress of the work or after their completion except accepted matters shall be settled through arbitration process as per the Arbitration & Conciliation Act, 1996. The venue of arbitration shall be Mysuru, Karnataka.

While processing a case for dispute resolution/ litigation/ arbitration, BNPM is to take legal advice at appropriate stages.

- a. Adjudication
- b. Mediation
- c. Arbitration

Excepted Matters: Matters for which provision has been made in any clause of the contract shall be deemed as 'excepted matters' (matters not disputable/ arbitrable), and decisions of BNPM, thereon, shall be final and binding on the contractor.

24. **Legal Jurisdiction:** The Courts of Mysuru (Karnataka State) shall alone have jurisdiction to decide on any legal matter of dispute whatsoever arising out of or in respect of the contract.
25. **Rights of Rejection:** BNPMIPL reserves the right to reject any or all the applied bids without assigning any reason whatsoever. The enquiry can be rejected on national security grounds.
26. **Preference for Micro and Small Enterprises (*MSEs):** Public procurement policy for Micro and Small Enterprises (MSEs) order, 2012 as notified by Govt of India (GOI) along with its amendments as available in www.msme.gov.in shall be applicable to this tender.
 - a. Micro and Small Enterprises (MSEs) should have valid UDYAM Registration Certificate to avail purchase preference under preference for Micro and Small Enterprises (*MSEs).
 - b. MSMEs having major activity as "Trading" for availing benefits of Priority Sector Lending (PSL) only are excluded from the purview of the policy. Any other benefits, including provisions of delayed payments as per MSMED ACT 2006 are excluded.
 - c. Tenderer's applying for purchase preference benefit has to claim the same at the appropriate place provided in this tender document.
 - d. Purchase Preference benefit will be given to those bidders, who are registered under tendered item group (Applicable NIC Code).
27. JV/Consortium /agents are not allowed.



SECTION II – TERMS & CONDITIONS

I/we engage to supply the material(s) to your engineering store, BNPMIPL and comply the following:

1. Tender schedule and technical specification indicated.
2. Item/tender specific conditions for this tender.
3. Terms and conditions of this tender.
4. I/we confirm that set off for the GST, etc. paid on the inputs have been taken into consideration in the above quoted price and further agree to pass on such additional duties as sets offs as may become available in future under GST, etc.
5. This offer is **valid** for **90 (Ninety) days** from the date of opening of the tender.
6. That, we have not been debarred by BNPMIPL/BRBNMPL/SPMCIL and any other Government/ Undertakings (Annexure-B enclosed).
7. Whether bidder is registered with Ministry of MSME? If yes, enterprise type as per UDYAM [Tick as applicable]
 - Manufacturing
 - Services
 - Trading
8. Whether bidder has claimed Purchase preference? [Tick as applicable]
 - YES [NIC Code as per UDYAM: _____]
 - NO
9. Start up detail: DPIIT Certificate No: _____
Validity: _____

Place & Date:		Name of Authorized Signatory:	
Signature & Seal:		Tel. No/Fax. No/Mobile No:	
Address:		Email Id:	



SECTION III - TECHNICAL SPECIFICATIONS

Sch No.	Particulars	UOM	Quantity
1.	Bracket for Short former Housing at Washing unit; MOC- Cast Nylon; As per drawing BNPM/PM/354/2025-26	Nos	2
2.	Bracket for Short former Housing at Cover change stand; MOC- Cast Nylon; As per drawing BNPM/PM/355/2025-26	Nos	2
3.	Bracket for Mastervat Housing at Cover change stand; MOC- Cast Nylon; As per drawing BNPM/PM/355/2025-26	Nos	3
4.	Bracket for Mastervat Housing at Washing unit; MOC - Cast Nylon; As per drawing BNPM/PM/354/2025-26	Nos	4
5.	Input shaft of expansion cylinder height adjusting drive; as per DRG.NO:BNPM/PM/163/2020-21; MOC: SS316	Nos	2
6.	Piston rod for unwinding arm hydraulic cylinder, MOC: EN 19 with chrome coating, Drg. No: BNPM/FH/371/2025-26	Nos	3
7.	Bearing housing for double sided timer belt Intermediate pulley, Article No: 02210478, MOC: EN 19, Drg. No: BNPM/FH/372/2025-26	Nos	3
8.	Shaft for double sided timer belt Intermediate pulley, Article No: 01700778, MOC: EN 19, Drg. No: BNPM/FH/373/2025-26	Nos	5
9.	Tensioner pulley for Belt No 35, Article No: 03030339, MOC: EN 19, Drg. No: BNPM/FH/374/2025-26	Nos	3
10.	Tie rod set for cross cutter, Article No: 80834706, MOC: EN 19, Drg. No: BNPM/FH/375/2025-26 Each set should have following items,	Sets	3



SECTION III - TECHNICAL SPECIFICATIONS

Sch No.	Particulars	UOM	Quantity
	1. Tie rod- 1No, 2. Hex locking pin-2 No's, 3. Locking pin -2 No's, 4. Spacer-4 No's		
11.	Eccentric bush for Overlapping rubber roll, Article No: 02050213, MOC: E 350, Drg. No: BNPM/FH/376/2025-26	Nos	10
12.	Flat pulley for Double gate, Article No: 03090802, MOC: E 350, Drg. No: BNPM/FH/377/2025-26	Nos	3
13.	Mating flange for densifier opening BIVIS I ,DRG / PP / 38 / 2021-22, MOC TEFLON Tech details:- <ul style="list-style-type: none"> Mating flange for densifier opening BIVIS I as per drawing BNPM /PP / 038 /2020-21. MOC : Teflon (PTFE). All holes and threaded portion must be done as per drawing. Plate Thickness: 20MM . Successful bidder needs to provide good surface finish on both the side after the making the mating flange with good Engg practise. Chamfering to done as 2 mm X 45°. M8 bolt should match to the fixed helicoil . SS helicoil need to be fixed on all 10 holes . 	Nos	1
14.	Mating flange for BIVIS I opening, DRG / PP / 39 / 2021-22, MOC TEFLON Tech details:-	Nos	1



SECTION III – TECHNICAL SPECIFICATIONS

Sch No.	Particulars	UOM	Quantity
	<ul style="list-style-type: none">• Mating flange for BIVIS I opening as per drawing BNPM /PP / 039 /2020-21 .• MOC: Teflon (PTFE)• All holes and threaded portion must be done as per drawing• Plate Thickness: 20MM• Successful bidder needs to provide good surface finish on both the side after the making the mating flange with good Engg practice.• Chamfering to done as 2 mm X 45°		

Required Delivery Schedule:

- a. Successful bidder needs to submit the dimensional report of all items of purchase order.
- b. It is successful bidders' responsibility to ensure the MOC of the items and also, they need to submit the Material test certificate.
- c. No separate inspection charges will be accepted by BNPM, Mysore.
- d. Successful bidder should supply one number in each item of purchase order for inspection at BNPM.
- e. BNPM, Mysuru will inspect and provide the clearance of inspection by mail to the successful bidder within 7 days from the date of receipt of material at BNPM, Mysore.
- f. In case the inspection is failed then the successful bidder has to repeat the same and to confirm purchase order specification. This entire sample inspection process to be completed within 30 days from the receipt of purchase order
- g. After getting the inspection clearance from BNPM, the successful bidder needs to supply all the balance materials of the order within 2 months (i.e., from the date of intimation of inspection clearance by BNPM). BNPM reserves the right to inspect the supplied items & if any deviation is found from the inspection cleared samples, then the supplied items will be rejected and reinspection to be provided.
- h. Successful bidder has to collect the rejected item at their own risk & cost from BNPM, Mysore site at a mutually agreed date & time. However, the entire ordered items should be supplied & accepted by BNPM within 14 weeks from the date of issuance of order, beyond which LD will be applicable.



(To be signed & stamped MSDS and submitted along with Techno-commercial Bid Part -I)

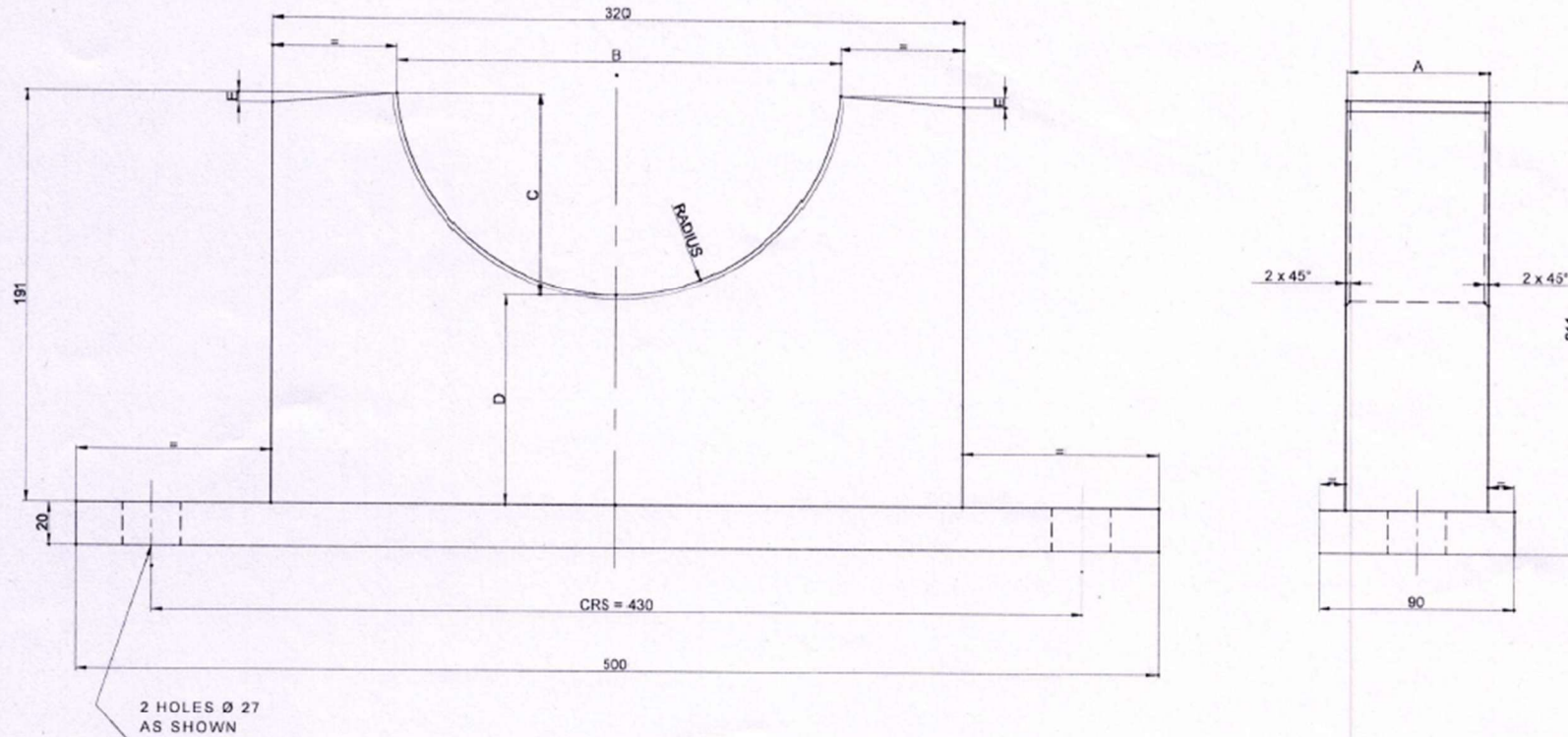

SECTION III - TECHNICAL SPECIFICATIONS

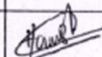

ITEM	A	B	C	D	E	RADIUS
SHORTFORMER	66	204.80	94	97	5	103
MASTERVAT	55	250	114	77	3	125

		BANK NOTE PAPER MILL INDIA PRIVATE LIMITED MYSORE - 570003	
BANK NOTE PAPER MILL INDIA PRIVATE LIMITED		BRACKET FOR MASTERVAT AND SHORTFORMER HOUSING AT WASHING UNIT	
PREPARED BY		DATE	12/12/25
CHECKED BY		DATE	12-12-25
APPROVED BY		DATE	13/12/25
		MOC: CAST NYLON	
		DRG.NO:BNPM / PM / 354 / 2025-26	



SECTION III - TECHNICAL SPECIFICATIONS

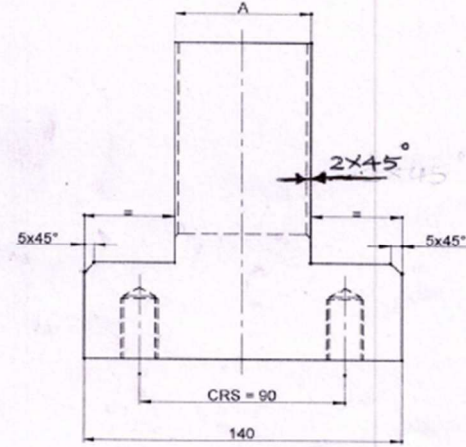
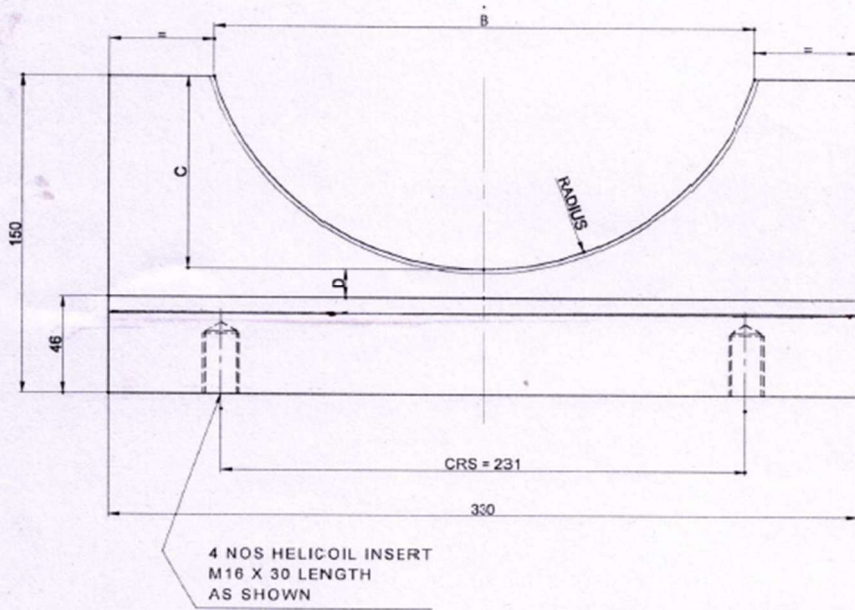

ITEM	A	B	C	D	RADIUS
MASTERVAT	60	240	90	14	125
SHORT FORMER	70	190	67	37	103



		BANK NOTE PAPER MILL INDIA PRIVATE LIMITED MYSORE - 570003	
BANK NOTE PAPER MILL INDIA PRIVATE LIMITED			
	SIGNATURE	DATE	BRACKET FOR MASTERVAT AND SHORTFORMER HOUSING AT COVER CHANGE STAND
PREPARED BY	<i>[Signature]</i>	12/12/25	
CHECKED BY	<i>[Signature]</i>	02.12.25	
APPROVED BY	<i>[Signature]</i>	13/12/25	MOC: CAST NYLON
			DRG.NO:BNPM / PM /355/ 2025-26

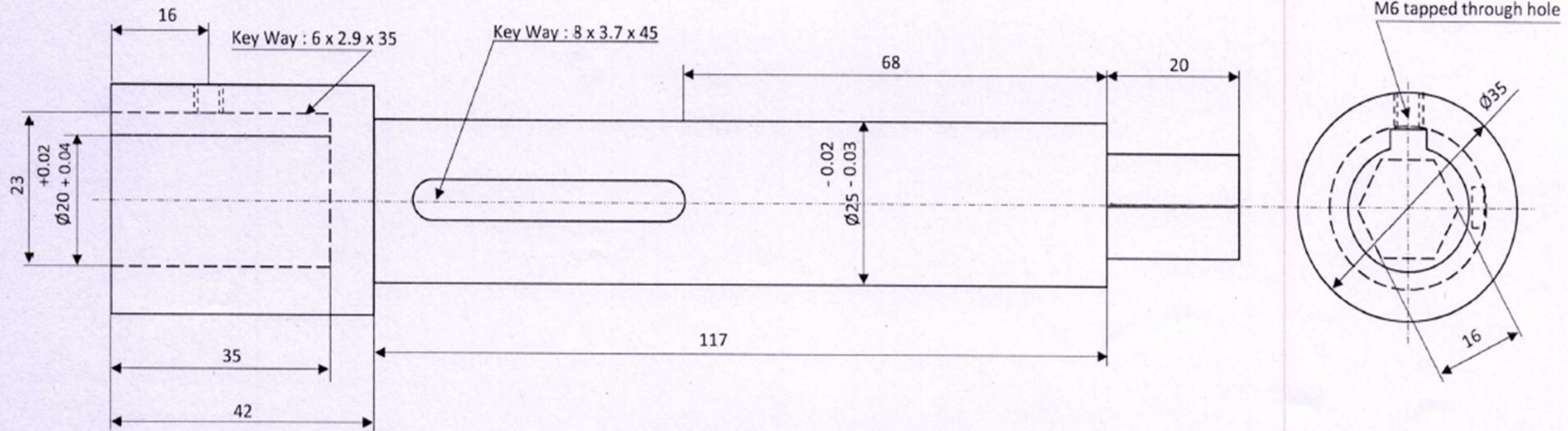

SECTION III - TECHNICAL SPECIFICATIONS



ALL DIMENSIONS ARE IN 'MM' UNLESS UNTIL SPECIFIED.
 ALL KEYWAY DIMENSIONS ARE AS PER STANDARD.
 TOLERANCE WHICH ARE NOT SPECIFIED SHOULD BE WITH IN +/-0.1MM
 ALL CORNERS TO BE ROUNDED OFF

 BANK NOTE PAPER MILL INDIA PRIVATE LIMITED MYSORE-570003			
	SIGNATURE	DATE	Input shaft for expansion cylinder height adjusting drive
PREPARED BY	<i>[Signature]</i>	13/11/25	MOC : S.S 316
CHECKED BY	<i>[Signature]</i>	13/11/25	DRG.NO:BNPM/PM/163/2020-21
APPROVED BY	<i>[Signature]</i>	13/11/25	



SECTION III - TECHNICAL SPECIFICATIONS

Input Shaft for Expansion cylinder:



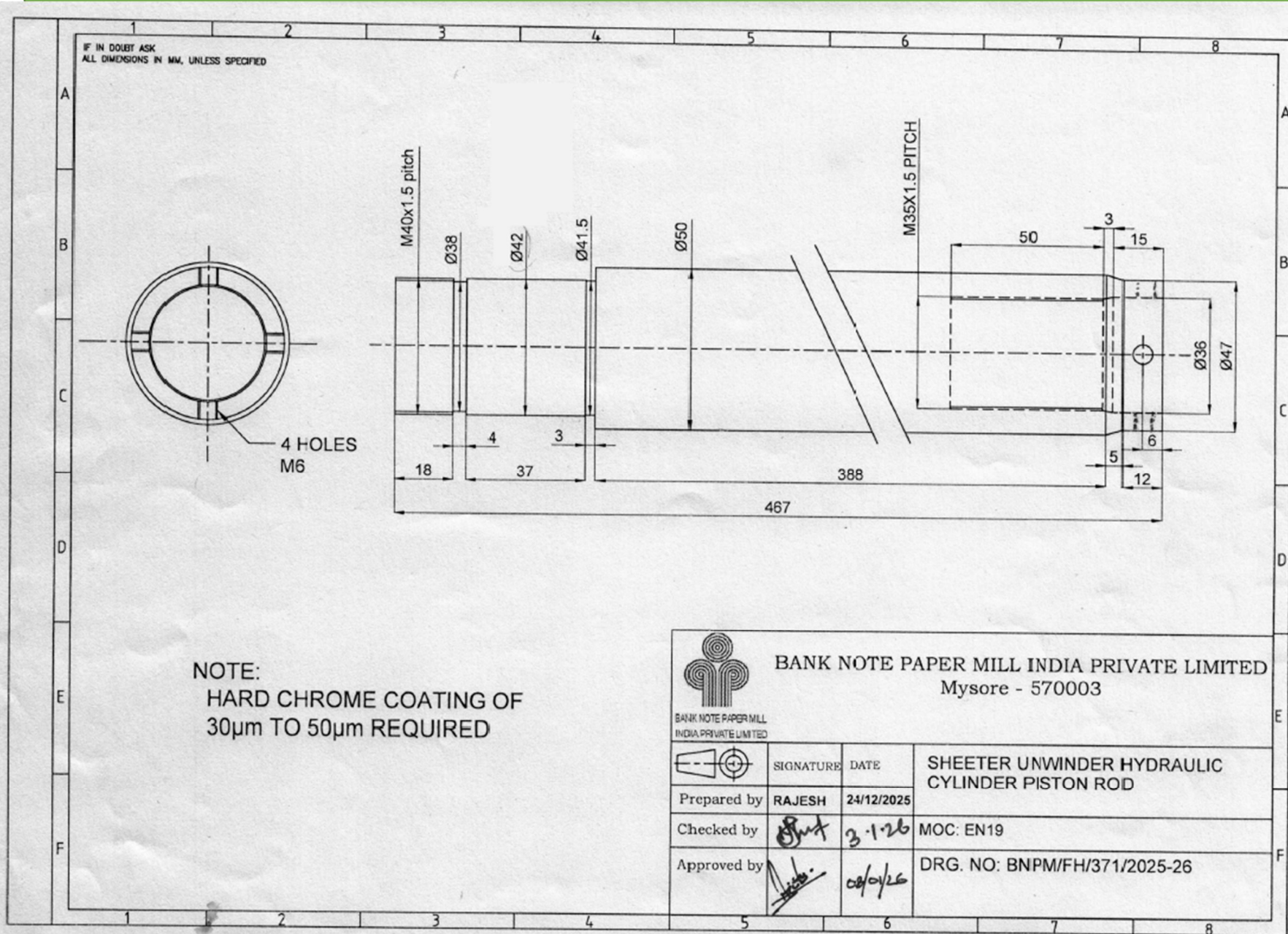

SECTION III - TECHNICAL SPECIFICATIONS

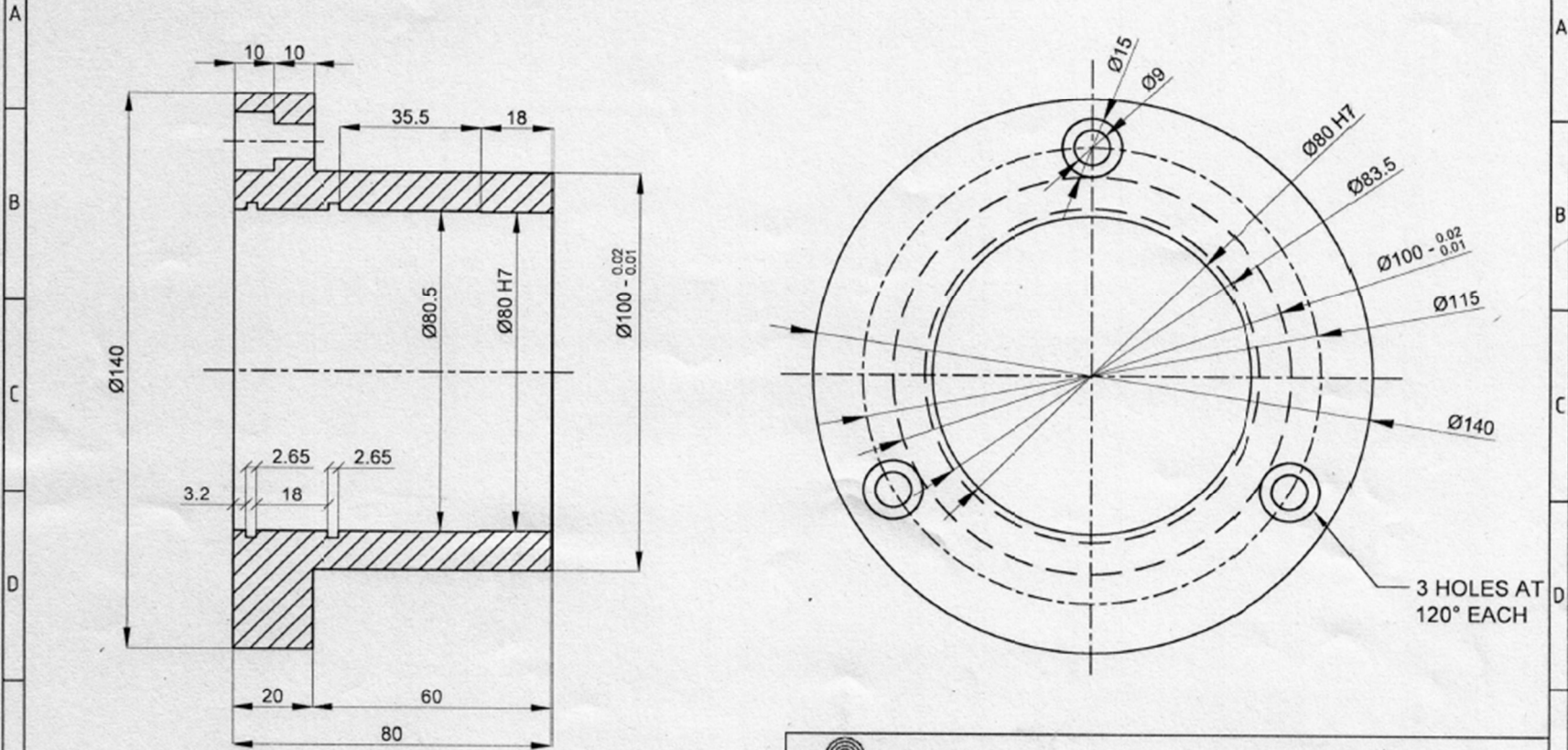

SECTION III - TECHNICAL SPECIFICATIONS

IF IN DOUBT ASK
ALL DIMENSIONS IN MM, UNLESS SPECIFIED



 BANK NOTE PAPER MILL INDIA PRIVATE LIMITED Mysore - 570003			
	SIGNATURE	DATE	SHEETER DOUBLE SIDED BELT INTERMEDIATE PULLEY HOUSING
	Prepared by RAJESH	27/12/2025	ARTICLE NO : 02210478
	Checked by <i>[Signature]</i>	29/12/25	MOC: EN19
	Approved by <i>[Signature]</i>	03/01/26	DRG. NO: BNPM/FH/372/2025-26



SECTION III - TECHNICAL SPECIFICATIONS

IF IN DOUBT ASK
ALL DIMENSIONS IN MM, UNLESS SPECIFIED

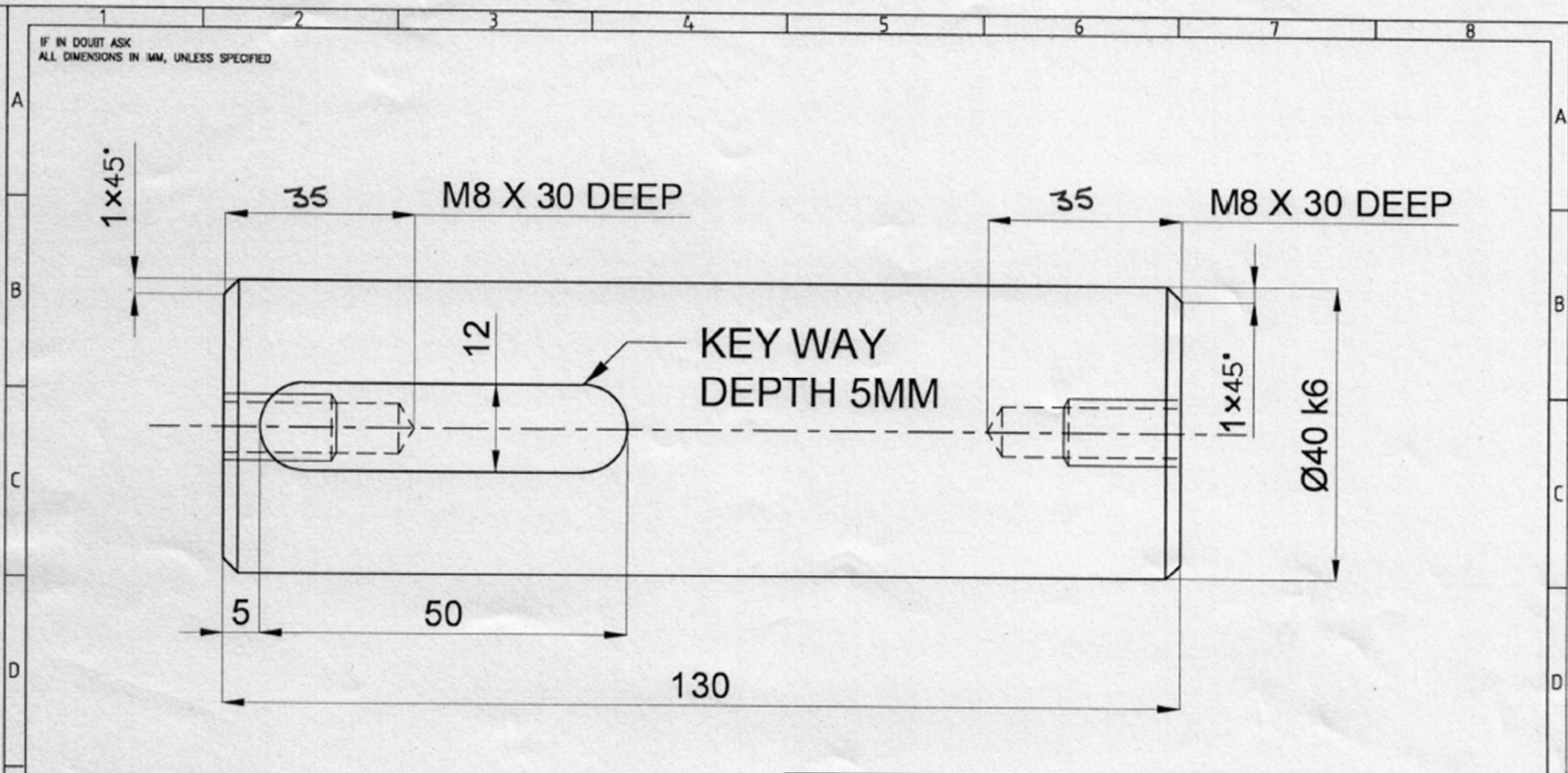

KEY WAY TO BE MAINTAINED AS PER: DIN 6885
Part - 1

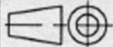
 BANK NOTE PAPER MILL INDIA PRIVATE LIMITED Mysore - 570003			
	SIGNATURE	DATE	SHEETER DOUBLE SIDED BELT INTERMEDIATE PULLEY SHAFT ARTICLE NO : 01700778 MOC: EN19 DRG. NO: BNPM/FH/373/2025-26
Prepared by	RAJESH	24/12/2025	
Checked by	<i>[Signature]</i>	29-12-25	
Approved by	<i>[Signature]</i>		



SECTION III - TECHNICAL SPECIFICATIONS

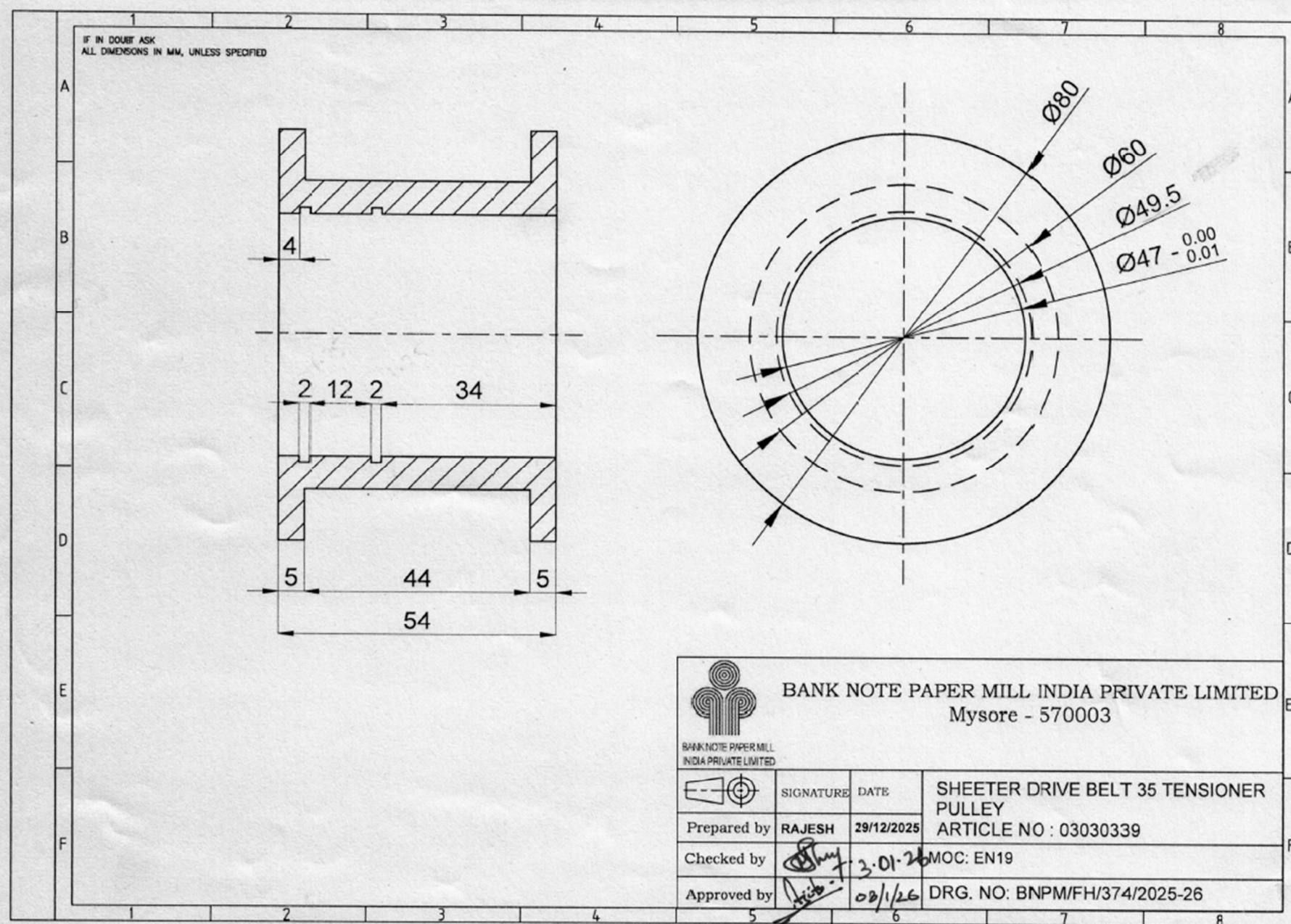

SECTION III - TECHNICAL SPECIFICATIONS

IF IN DOUBT ASK
ALL DIMENSIONS IN MM, UNLESS SPECIFIED

1.

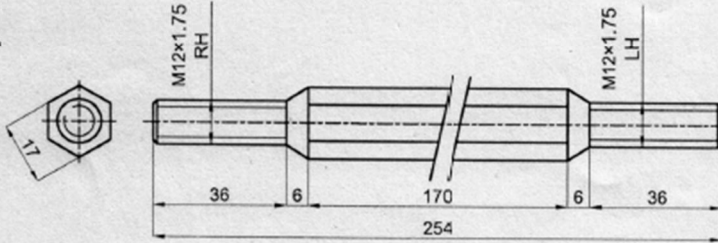

2.

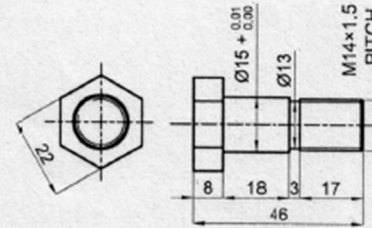

3.

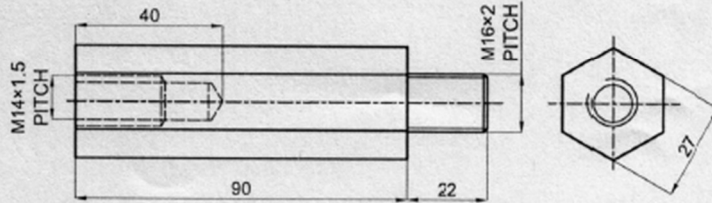

S.NO	PART NAME	QTY
4	SPACER	4
3	LOCKING PIN	2
2	HEX LOCKING PIN	1
1	TIE ROD	1

4.

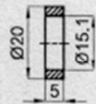

BANK NOTE PAPER MILL INDIA PRIVATE LIMITED
Mysore - 570003

BANK NOTE PAPER MILL
INDIA PRIVATE LIMITED

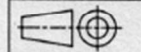

SIGNATURE DATE

SHEETER CROSS CUTTER TIEROD
ARTICLE NO : 80834706

Prepared by **RAJESH** 03/01/2026

Checked by *[Signature]* 31/26

MOC: EN19

Approved by *[Signature]* 08/01/26

DRG. NO: BNPM/FH/375/2025-26



SECTION III - TECHNICAL SPECIFICATIONS

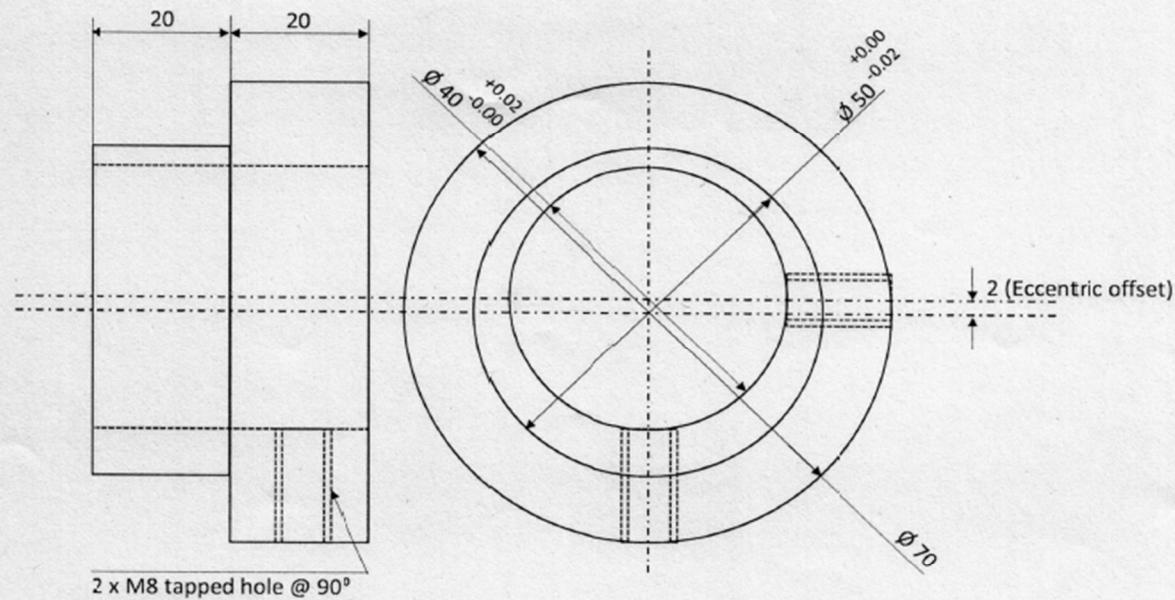



 BANK NOTE PAPER MILL INDIA PRIVATE LIMITED MYSORE-570003			
	SIGN	DATE	Eccentric bush for Overlapping rubber roll (Art:02050213)
PREPARED BY	<i>[Signature]</i>	09-01-26	
CHECKED BY			MOC : E 350
APPROVED BY	<i>[Signature]</i>	08/01/26	DRG.NO. :BNPM/FH/376/2025-26

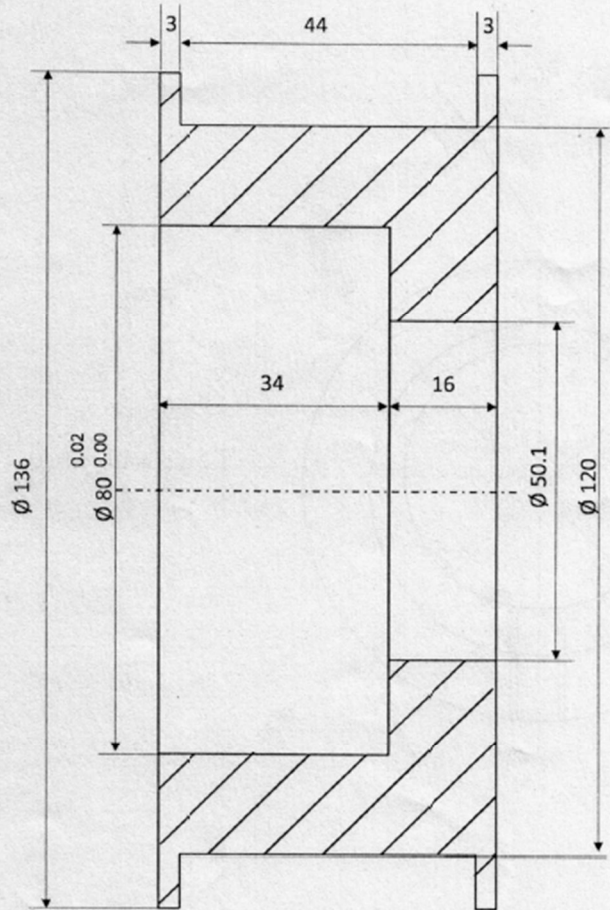

SECTION III - TECHNICAL SPECIFICATIONS



 BANK NOTE PAPER MILL INDIA PRIVATE LIMITED MYSORE-570003		Flat Pulley for Double gate Art .No : 03090802	
PREPARED BY	SIGN 	DATE	08-01-26
CHECKED BY			MOC : E 350
APPROVED BY 		DATE	08/01/26
		DRG.NO. :BNPM/FH/377/2025-26	



SECTION III - TECHNICAL SPECIFICATIONS

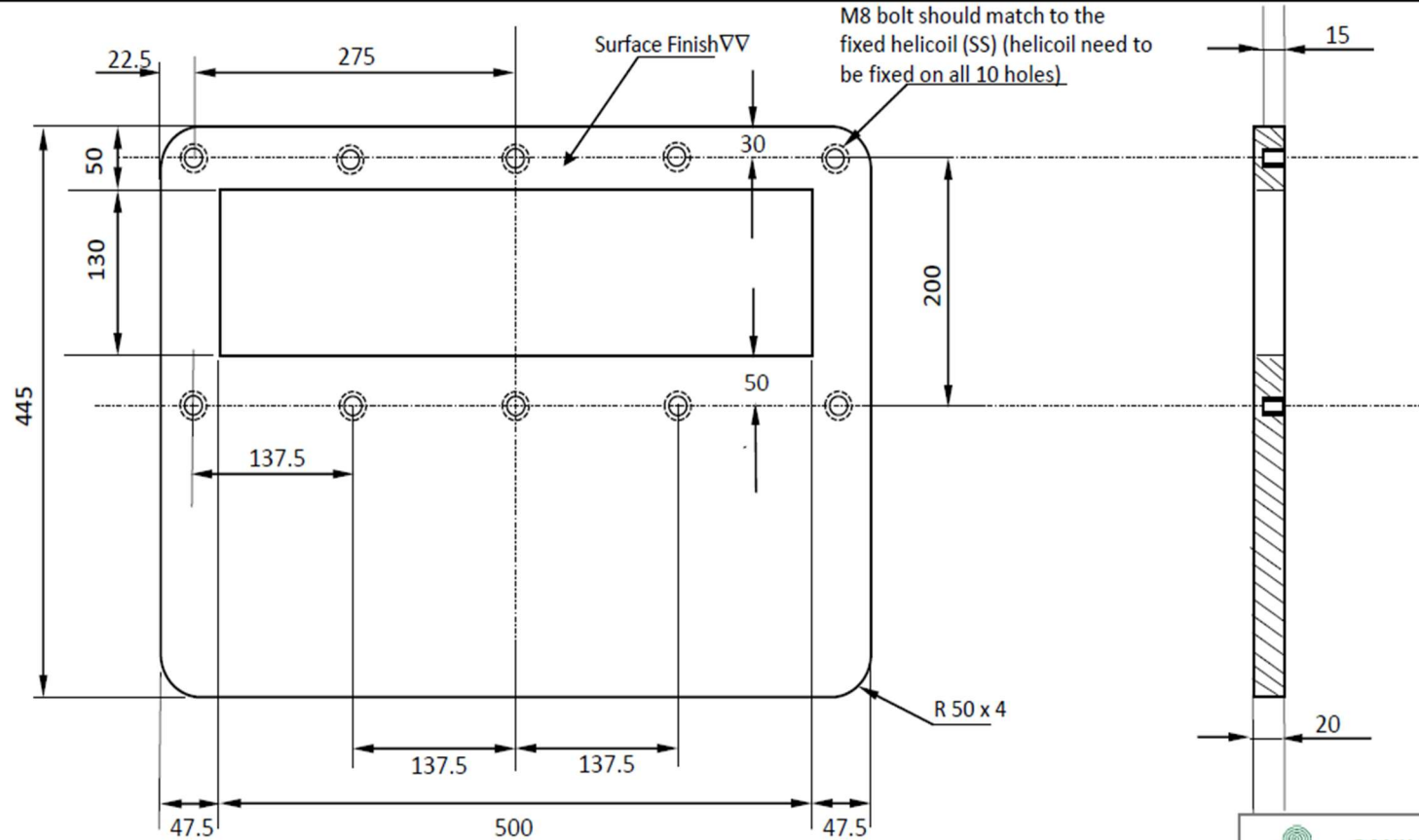

- 1: All dimensions are in mm
- 2: Chamfering is to be done both in and outside edges with 2 mm X 45°
- 3: Good surface finish to be maintained on either surface.
- 4: M8 bolt should match to the fixed helicoil
- 5: SS helicoil need to be fixed on all 10 holes

 BANK NOTE PAPER MILL INDIA PRIVATE LIMITED MYSORE-570003			
	SIGNATURE	DATE	Mating Flange for Densifier opening MOC : PTFE (Teflon) DRG.NO:BNPM/PP/38/2021-22
PREPARED BY	N GUPTA	14/06/2021	
CHECKED BY	Abhishek	14/06/2021	
APPROVED BY			



SECTION III - TECHNICAL SPECIFICATIONS

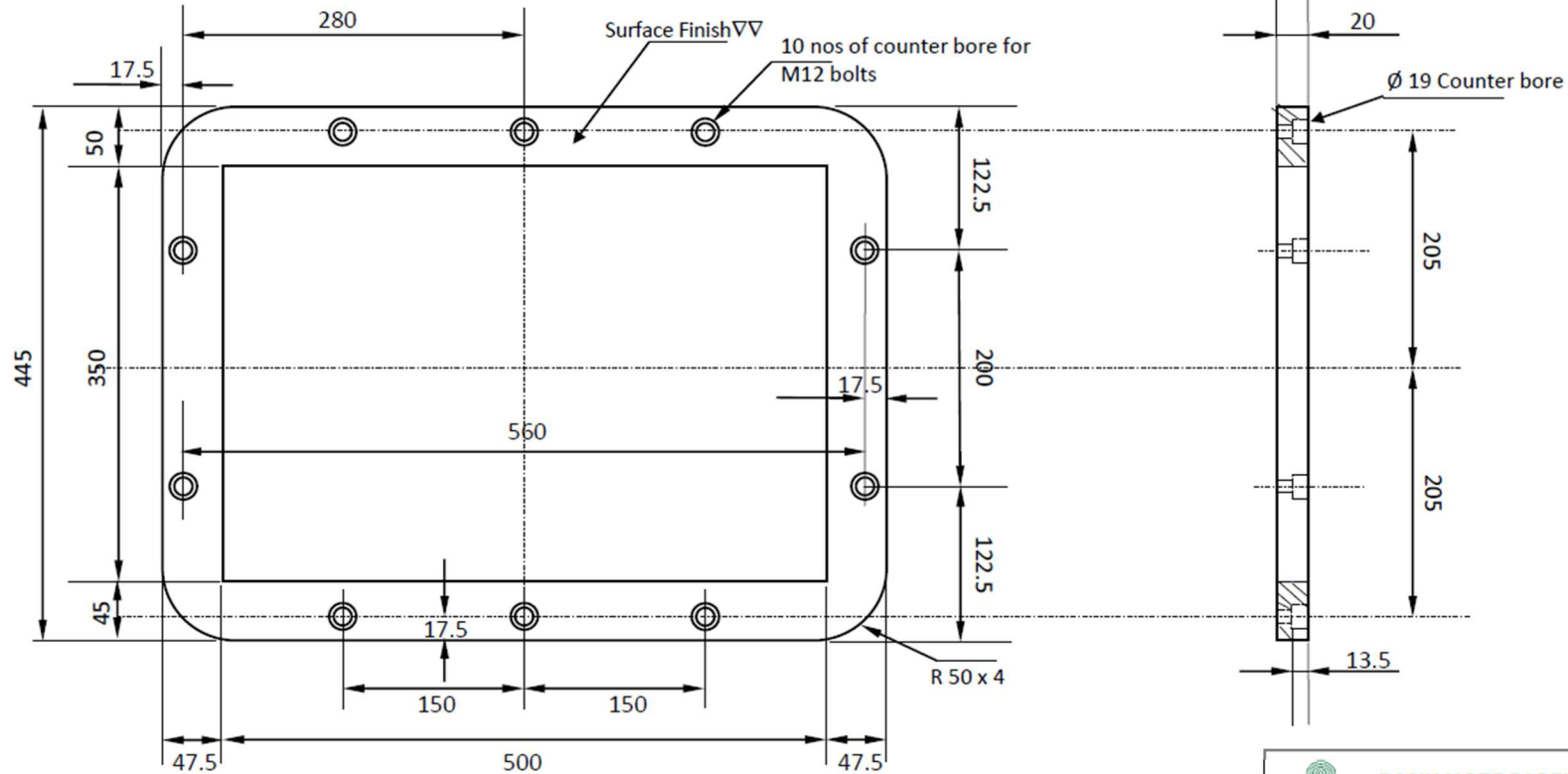

- 1: All dimensions are in mm
- 2: Chamfering is to be done both in and outside edges with 2 mm X 45°
- 3: Good surface finish to be maintained on either surface.

BANK NOTE PAPER MILL INDIA PRIVATE LIMITED MYSORE-570003			
	SIGNATURE	DATE	Mating Flange for BIVIS 01 opening (Bottom Half) MOC :PTFE (Teflon) DRG.NO:BNPM/PP/39/2021-22
PREPARED BY	N GUPTA	14/06/2021	
CHECKED BY	Abhishek	14/06/2021	
APPROVED BY			



SECTION IV – QUALITY CONTROL REQUIREMENTS

1. **Quality:** Quality is essence of this tender. The bidder shall supply the material as per the specifications mentioned in Technical Specifications. The material supplied will be inspected at our factory. Quantity as ascertained on receipt of above material at our site will be treated as quantity supplied wherever the package/materials are received intact.
2. **Rejection:** Materials not meeting our specification will be rejected outright and the rejected material shall be taken back within 7 days at the cost and risk of the supplier and replacement should be made within 15 days from the date of intimation or any other mutually agreed period. No payment shall be made for rejected item.

A) TECHNICAL COMPLIANCE STATEMENT:

Item No.	Particulars	Offered Specifications	Deviations (if any)
1.	Bracket for Short former Housing at Washing unit; MOC- Cast Nylon; As per drawing BNPM/PM/354/2025-26		
2.	Bracket for Short former Housing at Cover change stand; MOC- Cast Nylon; As per drawing BNPM/PM/355/2025-26		
3.	Bracket for Mastervat Housing at Cover change stand; MOC- Cast Nylon; As per drawing BNPM/PM/355/2025-26		
4.	Bracket for Mastervat Housing at Washing unit; MOC - Cast Nylon; As per drawing BNPM/PM/354/2025-26		
5.	Input shaft of expansion cylinder height adjusting drive; as per DRG.NO:BNPM/PM/163/2020-21		
6.	Piston rod for unwinding arm hydraulic cylinder, MOC: EN 19 with chrome coating, Drg. No: BNPM/FH/371/2025-26		
7.	Bearing housing for double sided timer belt Intermediate pulley, Article No: 02210478, MOC: EN 19, Drg. No: BNPM/FH/372/2025-26		
8.	Shaft for double sided timer belt Intermediate pulley, Article No:		



SECTION IV – QUALITY CONTROL REQUIREMENTS

	01700778, MOC: EN 19, Drg. No: BNPM/FH/373/2025-26		
9.	Tensioner pulley for Belt No 35, Article No: 03030339, MOC: EN 19, Drg. No: BNPM/FH/374/2025-26		
10.	Tie rod set for cross cutter, Article No: 80834706, MOC: EN 19, Drg. No: BNPM/FH/375/2025-26		
11.	Eccentric bush for Overlapping rubber roll, Article No: 02050213, MOC: E 350, Drg. No: BNPM/FH/376/2025-26		
12.	Flat pulley for Double gate, Article No: 03090802, MOC: E 350, Drg. No: BNPM/FH/377/2025-26		
13.	Mating flange for densifier opening BIVIS I ,DRG / PP / 38 / 2021-22, MOC TEFLON		
14.	Mating flange for BIVIS I opening ,DRG / PP / 39 / 2021-22, MOC TEFLON		
Acceptance to Scope of supply, Quality Parameters & all the drawings			

(Acceptance to deviations shall be at sole discretion of BNPM. In case of non-acceptance of deviations, bid is liable to be rejected. Interested bidders may get pre-clarifications to technical deviations from BNPM prior to submission of bid to avoid rejection of bids at a later stage.)

B) COMMERCIAL COMPLIANCE STATEMENT

Sl. No.	Features	Requirements of BNPMIPL, Terms & conditions	Whether Agreed by the firm	Deviation, if any
1.	Payment Terms	As mentioned in Sl.No.3 of Section II	Yes agreed	
2.	Delivery Schedule	As mentioned in Sl.No.4 of Section II	Yes agreed	
3.	Liquidated Damages	As mentioned in Sl.No.5 of Section II	Yes agreed	
4.	Risk Purchase	As mentioned in Sl. No.15 of Section II	Yes agreed	
5.	All other terms & conditions as mentioned in tender		Yes agreed	
6.	No. of pages	Total number of pages in Techno-Commercial Bid		



SECTION V - DECLARATIONS

ANNEXURE -A

E-Tender No: BNPM/LTE/70/2026-27, dated: 22.05.2026.

(To be submitted on the letterhead)

- I) *Any bidder from a country which shares a land border with India will be eligible to bid in the tender only if the bidder is registered with the Competent Authority (The Registered Committee constituted by the Department for Promotion of Industry and Internal Trade).
- II) Bidder means any person or firm or company, including any member of a consortium or joint venture (that is an association of several persons, or firms, or companies), every artificial judicial person not falling in any of the descriptions of bidders stated hereinbefore, including any agency branch or office controlled by such person participating in a procurement process.
- III) "Bidder from a country which shares a land border with India" for the purpose of this order means:-
- An entity incorporated, established or registered in such a country; or
 - A subsidiary controlled through entities incorporated, established or registered in such a country, or
 - An entity substantially controlled through entities incorporated, established or registered in such a country, or
 - An entity whose beneficial owner is situated in such a country; or
 - An India (or other) agent of such an entity; or
 - A natural person who is a citizen of such a country; or
 - A consortium or joint venture where any member of the consortium or joint venture falls under any of the above.
- IV) The beneficial owner for the purpose of (iii) above will be as under:-
- In case of a company or limited liability partnership, the beneficial owner is the natural person (s), who, whether acting alone or together, or through one or more judicial person, has a controlling ownership interest or who exercise control through other means.

Further explanation:

- "Controlling ownership interest" means ownership of or entitlement to more than twenty five per cent of shares or capital or profits of the company;
 - "Control" shall include the right to appoint majority of the director or to control the management or policy decision including by virtue of their shareholding or management rights or shareholder agreements or voting agreements;
- In case of partnership firm, the beneficial owner is the natural person(s) who, whether acting alone or together, or through one or more judicial person, has ownership of entitlement to more than fifteen percent of capital or profits of the partnership;



SECTION V - DECLARATIONS

- 3) In case of an unincorporated association or body of individuals, the beneficial owner is the natural person(s), who, whether acting alone or together, or through one or more judicial person, has ownership of or entitlement to more than fifteen percent of the property or capital or profits of such association or body of individuals;
 - 4) Where no natural person is identified under (1) or (2) or (3) above, the beneficial owner is the relevant natural person who holds the position of senior managing official;
 - 5) In case of a trust, the identification of beneficial owners(s) shall include identification of the author of the trust, the trustee, the beneficiaries with fifteen percent or more interest in the trust and any other natural person exercising ultimate effective control over the trust through a chain of control or ownership.
- V) An agent is a person employed to do any act for any another, or to represent another in dealings with third persons.
- VI) The successful bidder shall not be allowed to sub contract works to any contractor from a country which shares a land border with India unless such contractor is registered with the Competent Authority.
- VII) A bidder is permitted to procure raw material, components, sub-assemblies etc. from the vendors from countries which shares a land border with India. Such vendors will not be required to be registered with the competent authority, as it is not regarded as sub-contracting.
- VIII) However, in case a bidder has proposed to supply finished goods procured directly/indirectly from the vendors from the countries sharing land border with India, such vendor will be required to be registered with the competent authority.
- IX) The registration shall be valid at the time of submission of bid and at the time of acceptance of bid.

I have read the above clause regarding restrictions on procurement from a bidder of a country which shares a land border with India. I hereby certify that M/s is not from such a country or, if from such a country, has been registered with the Competent Authority. I hereby certify that M/s fulfills all requirements in this regard and is eligible to be considered." (where applicable, evidence of valid registration by the Competent Authority shall be attached)

I, the undersigned, declare that the item **Mechanical Items** Originate in, (Name of the country).

Signature: _____

Name: _____

Designation: _____

Date: _____

Stamp of the Organization:



SECTION V - DECLARATIONS

ANNEXURE -B

E-Tender No: BNPM/LTE/70/2026-27, dated: 22.05.2026.

(To be submitted on the letterhead)

DECLARATION

We do hereby declare that,

1. As on the date of submission of bid against this tender, we are not in the list of ineligible/ blacklisted/ banned/ debarred entity by SPMCIL/ BRBNMPL/ BNPMIPL/any government agency for participating in its tenders.

Further, we agree, in case we got blacklisted/ banned/ debarred by SPMCIL/ BRBNMPL/ BNPMIPL/any Government Agency, any time prior to finalization of tender/ contract, our bid shall not be considered for further evaluation/ award of order.

2. We do hereby declare that we have read and understood all terms and conditions of tender document including Technical Specification, Quality Control Criteria and confirm to abide to those conditions without any counter conditions.
3. The director/proprietor of the bidding firm are not closely related to BNPMIPL.

In case, at any time the information furnished is found to be false, you may disqualify/ debar me/ us as deemed fit.

Signature: _____

Name: _____

Designation: _____

Date: _____

Stamp of the Organization:



SECTION V - DECLARATIONS

ANNEXURE C

BID SECURITY DECLARATION

E-Tender No: BNPM/LTE/70/2026-27, dated: 22.05.2026.

(To be submitted on the letterhead)

We, the undersigned, declare that we will automatically be suspended from being eligible for bidding in any tender with Bank Paper Mill India Private Limited, Mysore for the period of 12 months, if we are withdrawing our Bid during the period of bid validity (or) fail / refuse to execute the contract, if awarded.

Signature: _____

Name: _____

Designation: _____

Date: _____

Stamp of the Organization:



SECTION VI - PRICE BID FORMAT

(TO BE FILLED ONLINE THROUGH E-TENDER PORTAL)

Dear Sir,

Sub: PRICE BID FOR SUPPLY OF MECHANICAL ITEMS AT BNPM PLANT, MYSURU.

Ref: e-Tender No: BNPM/LTE/70/2026-27, dated: 22.05.2026.

We have received and understood the above tender enquiry and are pleased to submit our price bid as under:

Sch No.	Description (As per detailed technical spec mentioned in section III)	HSN COD E	Quant ity	UOM	Basic Unit price	P&F, Freight & Transit Insurance & any other charges(if any) per unit (FOR BNPM, Mysore)	Total Price (incl. of P&F, Freight, Transit Insurance & any other charges (if any) excl. of GST) (FOR BNPM, Mysore)	GST (%)	GST on Unit Price	Total Price (incl. of GST) (INR)
					(INR)	(INR)	(INR)		(INR)	(INR)
			A		B	C	$D=(B+C)*A$	E	$F=D*E$	$G=D+F$
1.	Bracket for Shortformer Housing at Washing unit; MOC- Cast Nylon; As per drawing BNPM/PM/354/2025-26		2	Nos						
2.	Bracket for Shortformer Housing at Cover change stand; MOC- Cast Nylon; As per drawing BNPM/PM/355/2025-26		2	Nos						
3.	Bracket for MasterVat Housing at Cover change stand; MOC- Cast Nylon; As per drawing BNPM/PM/355/2025-26		3	Nos						



SECTION VI - PRICE BID FORMAT

4.	Bracket for MasterVat Housing at Washing unit; MOC - Cast Nylon; As per drawing BNPM/PM/354/2025-26		4	Nos	
5.	Input shaft of expansion cylinder height adjusting drive; as per DRG.NO:BNPM/PM/163/2020-21		2	Nos	
6.	Piston rod for unwinding arm hydraulic cylinder, MOC: EN 19 with chrome coating, Drg. No: BNPM/FH/371/2025-26		3	Nos	
7.	Bearing housing for double sided timer belt Intermediate pulley, Article No: 02210478, MOC: EN 19, Drg. No: BNPM/FH/372/2025-26		3	Nos	
8.	Shaft for double sided timer belt Intermediate pulley, Article No: 01700778, MOC: EN 19, Drg. No: BNPM/FH/373/2025-26		5	Nos	
9.	Tensioner pulley for Belt No 35, Article No: 03030339, MOC: EN 19, Drg. No: BNPM/FH/374/2025-26		3	Nos	
10.	Tie rod set for cross cutter, Article No: 80834706, MOC: EN 19, Drg. No: BNPM/FH/375/2025-26		3	Set	

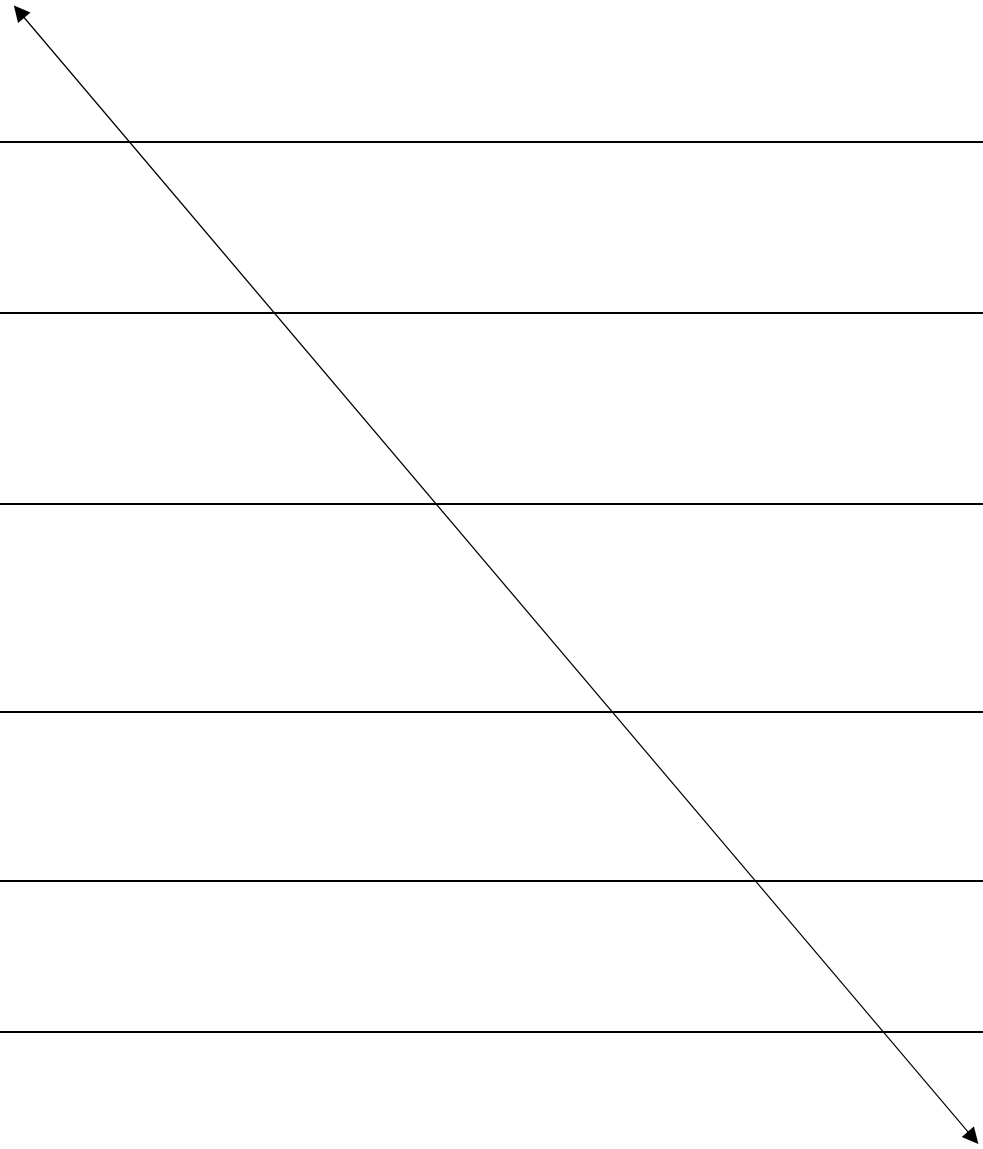

SECTION VI - PRICE BID FORMAT

11.	Eccentric bush for Overlapping rubber roll, Article No: 02050213, MOC: E 350, Drg. No: BNPM/FH/376/2025-26		10	Nos	
12.	Flat pulley for Double gate, Article No: 03090802, MOC: E 350, Drg. No: BNPM/FH/377/2025-26		3	Nos	
13.	Mating flange for densifier opening BIVIS I, DRG / PP / 38 / 2021-22, MOC TEFLON		1	Nos	
14.	Mating flange for BIVIS I opening ,DRG / PP / 39 / 2021-22, MOC TEFLON		1	Nos	
Total Effective price (net of input tax credit) for Supply of Mechanical Items at BNPM Plant, Mysuru with GST, Freight, P&F, Insurance & any other charges (F.O.R - Mysore site)					
Total Effective price (net of input tax credit) for Supply of Mechanical Items at BNPM Plant, Mysuru with GST, Freight, P&F, Insurance and any other charges (F.O.R - Mysore site) (IN WORDS)					

1. *Effective price will be calculated based on schedule wise lowest price i.e. (Unit Price, P&F, Insurance, Freight & GST amount) less input GST amount. L-1 status shall be decided considering schedule wise lowest effective price.*
2. *Bidder shall note that no extra cost will be considered over and above the price quoted in the price bid and hence bidder shall ensure that price submitted in the price bid is quoted considering complete technical specifications as defined in the tender document.*
3. *Bidder shall be eligible to pass on the input credit which has been deducted from Total price to arrive at Effective price*

Method of Evaluation: Evaluation shall be carried out on **schedule wise lowest effective price** quoted by the bidders, unless any other method of evaluation is specifically provided in the enquiry and contract shall be awarded to **schedule wise lowest (item wise L-1) bidders**. The quoted price should be inclusive of P&F, Freight, Transit Insurance and any other charges required for delivery of item to BNPM, Mysuru on F.O.R basis.



SECTION VI - PRICE BID FORMAT

Seal ()

Name

Signature with Date

Note: i) Price should be quoted exactly as per the format given above; Price bids with conditions / Counter conditions are liable for rejection.
ii) Multiple / Variable rate for single item, would lead to rejection of offer.

