

**NATIONAL COMPETITIVE BIDDING (NCB):e-TENDER NO. BNPM/NCB/CPPB/1024/19-20
SUPPLY OF COLLAPSIBLE PLYWOOD PACKING BOXES AT BNPM PLANT, MYSURU ON ANNUAL
RATE CONTRACT.**

**NATIONAL COMPETITIVE BIDDING
(ONLINE)**

Standard Bidding Document (SBD)

Procurement of Goods & Services

BANK NOTE PAPER MILL INDIA PRIVATE LIMITED

Administrative Building,

Gate 1, Paper Mill Compound

Note Mudran Nagar, Mysuru 570003

Phone: 0821-2401 174, FAX: 0821- 2401120

Website: www.bnpmindia.com; Email: bhoodhar@bnpmindia.com

Not Transferable

Security Classification: Non-security

**TENDER DOCUMENT FOR SUPPLY OF COLLAPSIBLE PLYWOOD PACKING BOXES AT BNPM
PLANT, MYSURU ON ANNUAL RATE CONTRACT.**

e-Tender No. BNPM/NCB/CPPB/1024/19-20 dated 10.01.2020

This tender document contains 62 pages

The tender document is sold to:

M/s.

Address _____

Details of Contact person in BNPMIPL regarding this tender:

Name: Mr. Bhoodhar Prasad Kewat, Designation: Assistant Manager

**Address: Bank Note Paper Mill India Private Limited
Administrative Building
Gate 1, Paper Mill Compound
Note Mudran Nagar, Mysuru - 570 003
Telephone No. 0821 - 2401 174**

**NATIONAL COMPETITIVE BIDDING (NCB):e-TENDER NO. BNPM/NCB/CPPB/1024/19-20
SUPPLY OF COLLAPSIBLE PLYWOOD PACKING BOXES AT BNPM PLANT, MYSURU ON ANNUAL
RATE CONTRACT.**

List of Contents

Section I	Notice Inviting Tender	Enclosed
Section II	General Instructions to Tenderers (GIT)	Enclosed
Section III	Special Instructions to Tenderers (SIT)	Enclosed
Section IV	General Conditions of Contract (GCC)	Enclosed
Section V	Special Conditions of Contract (SCC)	Enclosed
Section VI	List of Requirements	Enclosed
Section VII	Technical Specifications	Enclosed
Section VIII	Quality Control Requirements	Enclosed
Section IX	Qualification / Eligibility Criteria	Enclosed
Section X	Tender Form	Enclosed
Section XI	Price Schedule	Enclosed
Section XII	Questionnaire	Enclosed
Section XIII	Bank Guarantee Form for EMD	Not Applicable
Section XIV	Manufacturer's Authorization Form	Enclosed
Section XV	Bank Guarantee Form for Performance Security	Enclosed
Section XVI	Contract Form	Not Applicable
Section XVII	Letter of Authority for attending a Bid Opening	Not Applicable
Section XVIII	Shipping arrangements for liner cargoes	Not Applicable
Section XIX	Proforma of Bills for Payments	Not Applicable
Section XX	Proforma for pre-contract integrity pact	Not Applicable

SECTION I – NOTICE INVITING TENDER

NATIONAL COMPETITIVE BIDDING Standard Bidding Document (SBD)

Procurement of Goods & Services

BANK NOTE PAPER MILL INDIA PRIVATE LIMITED

Administrative Building,
Gate 1, Paper Mill Compound
Note Mudran Nagar, Mysuru 570003
Phone: 0821-2401 174, FAX: 0821- 2401120

Website: www.bnpmindia.com; Email: bhoodhar@bnpmindia.com

Not Transferable

Security Classification: Non-security

e-Tender No. BNPM/NCB/CPPB/1024/19-20 dated 10.01.2020

E-tenders are invited from eligible and qualified tenderers for supply of following goods:

Sch. No.	Brief Description of Goods	Tentative Quantity (with unit)	**Earnest Money Deposit (in Rs.)	Remarks
1	Collapsible Packing Box (740x820x970)mm, Marking-D	24,000 Sets	Not applicable	Refer Section – VI for List of requirements
2	Collapsible Packing Boxes (740*800*970)MM, Marking CC	4,500 Sets		
3	Collapsible Packing Box-740x780x970 MM, Marking-C	9,000 Sets		
4	Collapsible Packing Box (740x740x970)mm, Marking-HD/L	3,000 Sets		
5	Collapsible Packing Boxes (710 x 840 x 970) mm Marking -XX	7,500 Sets		

** Submission of tender fee and EMD is exempted for Micro and small enterprises (MSEs) as per the Public Procurement Policy for MSEs Order, 2012. MSEs should be registered and also will continue to remain registered during the tender validity period with District Industries Centre (DIC) or Khadi and Village Industries Commission (KVIC) or Khadi and Industries Board (KVIB) or Coir Board or National Small Industries Commission (NSIC) or Directorate of Handicrafts and Handlooms or Udyog Aadhaar Memorandum or Any other body specified by Ministry of MSME).

Type of Tender (Two Bid / PQB / EOI / RC / Development / Indigenization / Disposal of Scrap / Security item etc.	Two Bid System (Part-I Techno-commercial bid & Part-II Financial /Price Bid)
Date of Sale of tender documents	From 10.01.2020 to 10.02.2020 (Online)
Tender processing fees	Rs. 5,000/- + taxes
Bid submission mode	Online Through e-tendering portal, www.tenderwizard.com/BNP

SECTION I – NOTICE INVITING TENDER

Closing date and time for receipt of tenders	10.02.2020 at 15.00 Hours (Online)
Opening date and time for tenders	10.02.2020 at 16.00 Hours (Online)

1. Interested tenderers may obtain further information about this requirement from the above office selling the documents. They may also visit our website www.tenderwizard.com/BNP mentioned above for further details.
2. Non-refundable Tender processing fee is Rs. 5,000/- per set plus applicable taxes. The payment shall be made through Electronic mode only.
3. Aspiring Bidders/Contractors who have not registered in e-tendering should register through the website E-Tendering (www.tenderwizard.com/BNP) for participating in the Online Tenders. The registration charges will be Rs. 3,000/- plus applicable taxes (per year) which needs to be paid through electronic mode only.
4. For details, registration and e-payment, please visit e-tendering website www.tenderwizard.com/BNP (or) contact Miss Smitha N (from KEONICS) 09686115309.
5. The NIT Form with standard tender documents will be accessible in the e-Tendering website (viz www.tenderwizard.com/BNP).
6. Class III Digital Signature Certificate (DSC) is mandatory to participate in e-Tenders. Participating bidders/Contractors have to make sure that they have the valid DSC. If not, they can procure from any of the RAs approved by CCA.
7. Bidders/Contractors should upload and attach all the Scanned copies of technical documents/certificates in e-tendering website www.tenderwizard.com/BNP pertaining to their eligibility criteria mentioned in the NIT, failing which, the bid will not be considered.
8. The tenderer shall satisfy BNPMIPL that they are competent and authorized to submit tender and/or to enter into a legally binding contract with the BNPMIPL. To this effect, any person giving a tender shall render documentary evidence that his signature on the tender submitted by him is legally binding upon himself, his firm or company as the case may be.
9. For those tenderers whose technical bids do not satisfy the eligibility criteria, their financial Bids will not be opened.
10. In the event of any of the above mentioned dates being declared as a holiday/ closed day for the purchase organization, the tenders will be sold/received/opened on the next working day at the appointed time.
11. The tender documents are not transferable.

Yours faithfully,

For and on behalf of BNPMIPL

Deputy General Manager

IMPORTANT POINTS AT A GLANCE FOR TENDERERS

1. Tenders are to be uploaded on e-tendering portal www.tenderwizard.com/BNP only in Two part bid system.
 - i) **Part-I - Prequalification Bid & Techno-commercial Bid:** Scanned copy of Technical offer (Technical specification/catalogue/brochure etc.), supportive documents related to eligibility criteria, Tax related documents etc. along with all sections of this tender (except section – XI which has to be submitted as mentioned in **Part II** below) signed & stamped in each & every page. (To be submitted through E-portal only).
 - ii) **Part II – Price Bid:**
Price shall be furnished through e-portal only.
Price offer submitted in any other format will be liable for rejection.
2. **TERMS OF DELIVERY:**
Delivery shall be made on FOR- Engineering Store, Note Mudran Nagar, Mysore, in stagared manner as per delivery schedule given by BNPMIPL. The quoted price should be inclusive of Transit Insurance.
3. **PERIOD OF CONTRACT**
The Rate contract is for a period of one year from the date of issue of LOI and later extendable further six months at the same rate, terms and conditions of tender.
4. **Quantity:** Annual rate contract. **(Refer list of requirements for tentative yearly quantity).**
5. **Liquidated Damage:** A sum equivalent to the 0.5% of the delivered price of the delayed goods for each week of delay or part thereof until actual delivery or performance, subject to a maximum deduction of the 10% of the delayed good's contract price.
6. **Security Deposit / Performance Security:**
10% of the yearly estimated value shall be submitted by the successful bidder within 21 days from the date of issue of work order. PBG shall be valid for 12 months from the date of successful commissioning plus 02 months claim period. Relevant validity dates shall be provided in the work order.
7. Performance of the bidder in executing the previous contracts/orders of BNPMIPL shall be taken into account during technical evaluation. The bids of the tenderers who were unsuccessful in completing the previous orders of BNPMIPL without any valid reason are liable to be ignored /rejected.
8. Parties who have been black listed /debarred by BNPMIPL/BRBNMPL/SPMCIL or any PSU or any Government Departments are not eligible for submission of this tender.
9. Bidder may visit BNPMIPL (if required), before submitting the offer after taking due permission to understand the requirements.
10. Copies of Certificates/Documents related to GST Registration, PAN and Professional Tax Registration Certificate etc. to be provided along with the Bid.
11. No counter conditions shall be accepted.
12. Bidders are advised to write the page number on each page of the Technical Bid documents submitted.

SECTION II – GENERAL INSTRUCTIONS TO TENDERES

Section II: General Instructions to Tenderers (GIT)

PART 1: GENERAL INSTRUCTIONS APPLICABLE TO ALL TYPES OF TENDERS

A. PREAMBLE

1. Introduction

1.1. Definitions and abbreviations which have been used in these documents shall have the meanings as indicated in GCC.

1.2. For convenience, whole of this Standard Bidding Document (including all sections) is written with reference to Procurement of Goods Tenders. However this SBD would be utilized for all types of Tenders e.g. EOI, PQB, Rate Contract, Tenders involving Samples, Sale/Disposal of Scrap Material and Development/ indigenization etc., Procurement of Services etc. Therefore the construction of all clauses are to be interpreted in the context of particular type of tender beyond the letter of the clause, read with the additional clauses for the specific type of tenders in Part II GIT/GCC. Sections, which are not applicable have been marked as Not Applicable

1.3. These tender documents have been issued for the requirements mentioned in Section- VI - "List of Requirements", which also indicates, inter-alia, the required delivery schedule and terms & place (i.e. destination) of delivery.

1.4. This section (Section II - General Instruction to Tenderers" - GIT) provides the relevant information as well as instructions to assist the prospective tenderers in preparation and submission of tenders. It also includes the mode and procedure to be adopted for receipt and opening as well as scrutiny and evaluation of tenders and subsequent placement of contract. With this limited objective, GIT is not intended to be complete by itself and the rest of this document- SIT, GCC and SCC in particular may also be thoroughly studied before filling up the Tender Document. There would be certain topics covered in GIT/SIT as well as in GCC/ SCC from different perspectives. In case of any conflict between these, provisions of GCC/ SCC would prevail.

1.5. The tenderers shall also read the Special Instructions to Tenderers (SIT) related to this purchase, as contained in Section III of these documents and follow the same accordingly. Whenever there is a conflict between the GIT and the SIT, the provisions contained in the SIT shall prevail over those in the GIT.

2. Language of Tender

The tender submitted by the tenderer and all subsequent correspondence and documents relating to the tender exchanged between the tenderer and BNPM, shall be written in the English language, unless otherwise specified in the Tender. However, the language of any printed literature furnished by the tenderer in connection with its tender may be written in any other language provided the same is accompanied by English translation. For purposes of interpretation of the tender, the English translation shall prevail.

3. Eligible Tenderers

This invitation for tenders is open to all suppliers who fulfil the eligibility criteria specified in these documents. Please refer to Section IX: Qualification/ Eligibility Criteria

4. Eligible Goods and Services

All goods and related services to be supplied under the contract shall have their origin in India or other countries, subject to any restriction imposed in this regard in Section III (SIT). The term "origin" used in this clause means the place where the goods are mined, grown, produced, or manufactured or from where the related services are

arranged and supplied.

5. Tendering Expense

The tenderer shall bear all costs and expenditure incurred and/ or to be incurred by it in connection with its tender including preparation, mailing and submission of its tender and for subsequent processing the same. BNPM will, in no case be responsible or liable for any such cost, expenditure etc. regardless of the conduct or outcome of the tendering process.

B. TENDER DOCUMENTS

6. Content of Tender Documents

6.1 The tender documents include:

VOLUME I

1. Notice Inviting Tender (NIT)
2. General Instructions to Tenderers (GIT)
3. Special Instructions to Tenderers (SIT)
4. General Conditions of Contract (GCC)
5. Special Conditions of Contract (SCC)
6. List of Requirements – Included in Volume II
7. List Of Approved Vendors
8. Quality Control Requirements
9. Qualification/Eligibility Criteria
10. Tender Form
11. Price Schedule
12. Commercial Questionnaire for indigenous & imported items
13. Bank Guarantee Form for EMD
14. Manufacturer's Authorization Form
15. Bank Guarantee Form for Performance Security
16. Contract Form
17. Letter of Authority for attending a Bid Opening
18. Shipping Arrangements for Liner Cargoes
19. Proforma of Bills for Payments
20. Additional conditions of works contract
21. Application for pre-qualification
22. Proforma for Integrity Pact

6.2 The relevant details of the required goods and services, the terms, conditions and procedure for tendering, tender evaluation, placement of contract, the applicable contract terms and, also, the standard formats to be used for this purpose are incorporated in the above-mentioned documents. The interested tenderers before formulating the tender and submitting the same to BNPM should read and examine all the terms, conditions, instructions etc. contained in the tender documents. Failure to provide and/ or comply with the required information, instructions etc. incorporated in these tender documents may result in rejection of its tender.

7. Amendments to Tender Documents

7.1 At any time prior to the deadline for submission of tenders, BNPM may, for any reason deemed fit by it, modify the tender

SECTION II – GENERAL INSTRUCTIONS TO TENDERES

- documents by issuing suitable amendment(s) to it.
- 7.2. Such an amendment will be notified in writing by registered/speed post or by fax/ telex/ e-mail, followed by copy of the same by suitable recorded post to all prospective tenderers, which have received the tender documents and will be binding on them.
- 7.3. In order to provide reasonable time to the prospective tenderers to take necessary action in preparing their tenders as per the amendment, BNPM may, at its discretion, extend the deadline for the submission of tenders and other allied time frames, which are linked with that deadline.
- 8. Pre-Bid Meeting**
If found necessary, a proposal to call for a pre-bid conference may be put-forth in the SIT, for clarification/amendment to Technical specifications/techno-commercial conditions in two bid tender.
- 9. Clarification of Tender Documents**
A Tenderer requiring any clarification or elucidation on any issue of the tender documents may take up the same with BNPM in writing or by fax I e-mail/ telex. BNPM will respond in writing to such request provided the same is received by BNPM not later than twenty one days (unless otherwise specified in the SIT) prior to the prescribed date of submission of tender. Copies of the query and clarification shall be sent to all prospective bidders who have received the bidding documents and/or hosted in its website.
- C. PREPARATION OF TENDERS**
- 10. Documents Comprising the Tender**
- 10.1. The tender to be submitted by Tenderer shall contain the following documents, duly filled in, as required:
- Tender Form and Price Schedule along with list of deviations (ref Clause 19.4) from the clauses of this SBD, if any.
 - Documentary evidence, as necessary in terms of GIT clauses 3 and 16 establishing that the tenderer is eligible to submit the tender and, also, qualified to perform the contract if its tender is accepted.
 - Documents and relevant details to establish in accordance with GIT clause 17 that the goods and the allied services to be supplied by the tenderer conform to the requirement of the tender documents along with list of deviations if any (ref clause 17.3 of GIT).
 - Earnest money furnished in accordance with GIT clause 18.1.
 - Commercial questionnaire for indigenous & imported items in Volume I.
 - Manufacturer's Authorization Form (ref Section XIV, if applicable)
- NB: The tenderers may also enclose in their tenders, technical literature and other documents as and if considered necessary by them.
- 10.2. A tender, that does not fulfil any of the above requirements and/ or gives evasive information/ reply against any such requirement, shall be liable to be ignored and rejected.
- 10.3. Tender sent by fax/email/ telex/ cable shall be ignored.
- 11. Tender currencies**
- 11.1. Unless otherwise specified, the tenderer shall quote only in Indian rupees.
- 11.2. Where the tender condition specifies acceptance of quotations in different currencies, then, for domestic goods, prices shall be quoted in INR only and for imported goods, prices shall be quoted either in INR or in the currency stipulated in the SIT, mentioning, inter-alia, the exchange rate adopted for converting foreign currency into INR. As regards price(s) for allied services, if any, required with the goods, the same shall be quoted in Indian Rupees if such services are to be performed I undertaken in India. Commission for Indian Agent, if any and if payable shall be indicated in the space provided for in the price schedule and quoted in INR only.
- 11.3. Tenders, where prices are quoted in any other way shall be treated as unresponsive and rejected.
- 12. Tender Prices**
- 12.1. The Tenderer shall indicate on the Price Schedule provided under Volume I all the specified components of prices shown therein including the unit prices and total tender prices of the goods and services it proposes to supply against the requirement. All the columns shown in the price schedule should be filled up as required. If any column does not apply to a tenderer, same should be clarified accordingly by the tenderer.
- 12.2. If there is more than one schedule in the List of Requirements, the tenderer has the option to submit its quotation for any one or more schedules and, also, to offer special discount for combined schedules. However, while quoting for a schedule, the tenderer shall quote for the complete requirement of goods and services as specified in that particular schedule.
- 12.3. The quoted prices for goods offered from within India and that for goods offered from abroad are to be indicated separately in the applicable Price Schedules attached under Volume I.
- 12.4. While filling up the columns of the price schedule, the following aspects should be noted for compliance:
- 12.5. For goods offered from within India, the prices in the corresponding price schedule shall be entered separately in the following manner:
- The price of the goods, quoted ex-factory, ex-showroom, ex-warehouse or off- the-shelf, as applicable including all taxes and duties like sales tax, VAT, custom duty, excise duty etc. already paid or payable on the components and raw material used in the manufacture or assembly of the goods quoted ex-factory etc. or on the previously imported goods of foreign origin quoted ex-showroom etc.
 - Any taxes/duties including excise duty, which will be payable on the goods in India if the contract is awarded.
 - Charges towards inland transportation, insurance and other local costs incidental to delivery of the goods to their final destination as specified in the List of Requirements and
 - The price of incidental services, as and if mentioned in List of Requirements.
- 12.6. For goods offered from abroad, the prices in the corresponding price schedule shall be entered separately in the following manner:
- The price of goods quoted FAS/FOB port of shipment, CIF port of entry in India or CIF specified place of destination in India as indicated the List of Requirements.
 - The amount of custom duty and import duty on the goods to be imported, wherever applicable.
 - The charges for inland transportation, insurance and other local costs incidental to delivery of the goods from the port of entry in India to their final destination, as specified in the List of Requirements and
 - The charges for incidental services, as and if mentioned in the List of Requirements.
- 12.7. Additional information and instruction on Duties and Taxes: If the Tenderer desires to ask for excise duty, sales tax, custom duty etc. to be paid extra, the same must be specifically stated. In the absence of any such stipulation the price will be taken inclusive of such duties and taxes and no claim for the same will be entertained later.
- 12.8. Excise Duty:
- If reimbursement of excise duty intended as extra over the quoted prices, the supplier must specifically say so also indicating the rate, quantum and nature of the duty applicable. In the absence of any such stipulation it will be presumed that the prices quoted are firm and final and no claim on account of excise duty will be entertained after the opening of tenders.
 - If a Tenderer chooses to quote a price inclusive of excise duty and also desires to be reimbursed for variation, if any, in the excise duty during the time of

SECTION II – GENERAL INSTRUCTIONS TO TENDERES

- supply, the tenderer must clearly mention the same and also indicate the rate and quantum of excise duty included in its price. Failure to indicate all such details in clear terms may result in statutory variations being denied to the tenderer.
- c) Subject to sub clauses 12.8 (a) & (b) above, any change in excise duty upward/ Downward as a result of any statutory variation in excise duty taking place within original Delivery Period shall be allowed to the extent of actual quantum of excise duty paid by the supplier. In case of downward revision in excise duty, the actual quantum of reduction of excise duty shall be reimbursed to BNPM by the supplier. All such adjustments shall include all reliefs, exemptions, rebates, concession etc. if any obtained by the supplier.
- 12.9. Sales Tax/ VAT/ CST/ GST/ Service Tax, work Contract Tax
If a tenderer asks for sales tax/ VAT/ CST/ GST/ Service Tax/ Work Contract Tax to be paid extra, the rate and nature of such taxes applicable should be shown separately. Such taxes will be paid as per the rate at which it is liable to be assessed or has actually been assessed provided the transaction of sale is legally liable to such taxes and is payable as per the terms of the contract. The tenderer shall examine the nature of transactions and applicability of taxes and duties.
- 12.10. Wherever Value Added Tax is applicable, the following may be noted:
- a) The tenderer should quote the exact percentage of VAT that they will be charging extra.
- b) While quoting the rates, tenderer should pass on (by way of reduction in prices) the set off/input tax credit that would become available to them by switching over to the system of VAT from the existing system of sales tax, duly stating the quantum of such credit per unit of the item quoted for.
- c) The tenderer while quoting for tenders should give the following declaration:
- "We agree to pass on such additional set off/input tax credit as may become available in future in respect of all the inputs used in the manufacture of the final product on the date of supply under the VAT scheme by way of reduction in price and advise the purchaser accordingly."
- d) The supplier while claiming the payment shall furnish the following certificate to the paying authorities: "We hereby declare that additional set offs/input tax credit to the tune of Rs.....has accrued and accordingly the same is being passed on to the purchaser and to that effect the payable amount may be adjusted.
- 12.11. Octroi and Local Taxes:
Unless otherwise stated in the SIT, the goods supplied against contracts placed by BNPM are not exempted from levy of Town Duty, Octroi Duty, Terminal Tax and other Levies of local bodies. In such cases, the supplier should make the payment to avoid delay in supplies and forward the receipt of the same to the purchasing department for reimbursement and also, for further necessary action. In cases where exemption is available, suppliers should obtain the exemption certificate from the purchasing department to avoid payment of such levies and taxes.
- 12.12. Duties/ Taxes on Raw Materials
BNPM is not liable for any claim from the supplier on account of fresh imposition and/or increase (including statutory increase) of excise duty, custom duty, sales tax etc. on raw materials and/or components used directly in the manufacture of the contracted goods taking place during the pendency of the contract, unless such liability is specifically agreed to in terms of the contract.
- 12.13. Imported Stores not liable to Above-mentioned Taxes and Duties:
Above mentioned Taxes and Duties are not leviable on imported Goods and hence would not be reimbursed.
- 12.14. Customs Duty:
In respect of imported stores offered from abroad, the tenderer shall specify the rate as well as the total amount of customs duty payable. The tenderer shall also indicate the corresponding Indian Customs Tariff Number applicable for the goods in question.
- 12.14.1. For transportation of imported goods offered from abroad, relevant instructions as incorporated under GCC Clause 11 shall be followed.
- 12.14.2. For insurance of goods to be supplied, relevant instructions as provided under GCC Clause 12 shall be followed.
- 12.14.3. Unless otherwise specifically indicated in this tender document, the terms FOB, FAS, CIF etc. for imported goods offered from abroad, shall be governed by the rules & regulations prescribed in the current edition of INCOTERMS, published by the International Chamber of Commerce, Paris
- 12.14.4. The need for indication of all such price components by the tenderers, as required in this clause (viz., GIT clause 12) is for the purpose of comparison of the tenders by BNPM and will no way restrict BNPM's right to award the contract on the selected tenderer on any of the terms offered.
13. **Indian Agent**
If a foreign tenderer has engaged an agent in India in connection with its tender, the foreign tenderer, in addition to indicating Indian agent's commission, if any, in a manner described under GIT sub clause 11.2 above, shall also furnish the following information:
- a) The complete name and address of the Indian Agent and its permanent income tax account number as allotted by the Indian Income Tax authority.
- b) The details of the services to be rendered by the agent for the subject requirement.
One manufacturer can authorize only one agent/Dealer. Also one agent cannot represent more than one supplier or quote on their behalf in a particular tender enquiry. Such quote is likely to be rejected. There can be only one bid from
- i.) The principal manufacturer directly or one Indian agent on his behalf.
- ii.) The foreign principal or any of its branch/ division
- iii.) Indian/ Foreign Agent on behalf of only one Principal.
14. **Firm Price/Variable Price**
- 14.1. Unless otherwise specified in the SIT, prices quoted by the tenderer shall remain firm and fixed during the currency of the contract and not subject to variation on any account.
- 14.2. In case the tender documents require offers on variable price basis, the price quoted by the tenderers will be subject to adjustment during original Delivery Period to take care of the changes in the cost of labour and material components in accordance with the price variation formula to be specified in the SIT. If a tenderer submits firm price quotation against the requirement of variable price quotation that tender will be prima-facie acceptable and considered further, taking price variation asked for by the tenderer as zero.
- 14.3. However, as regards taxes and duties, if any, chargeable on the goods and payable, the conditions stipulated in GIT clause 12 will apply for both firm price tender and variable price tender.
- 14.4. Subject to provisions of Clause 11 above, where prices are quoted in foreign currencies, involving imports - Foreign Exchange Rate Variation (ERV) would be borne by the Purchaser within the original Delivery Period. The offer of the Tenderer should indicate import content and the currency used for calculating import content.
- 14.5. Base Exchange rate of each major currency used for calculating FE content of the contract should be indicated. The base date of ERV would be contract date and variation on the base date can be given up to the midpoint manufacture, unless firm has already indicated the time schedule within which material will be imported by the firm.
- 14.6. In case delivery period is refixed/ extended, ERV will not be admissible, if this is due to default of the supplier.
- 14.7. Documents for claiming ERV:
- a) A bill of ERV claim enclosing working sheet
- b) Banker's Certificate/debit advice detailing F.E. paid and

SECTION II – GENERAL INSTRUCTIONS TO TENDERES

- exchange rate
- c) Copies of import order placed on supplier
- d) Invoice of supplier for the relevant import order
- 15. Alternative Tenders**
Unless otherwise specified in the Schedule of Requirements, alternative tenders shall not be considered.
- 16. Documents Establishing Tenderer's Eligibility and Qualifications**
- 16.1. Pursuant to GIT clause 10, the tenderer shall furnish, as part of its tender, relevant details and documents establishing its eligibility to quote and its qualifications to perform the contract if its tender is accepted.
- 16.2. The documentary evidence needed to establish the tenderer's qualifications shall fulfil the following requirements:
- a) In case the tenderer offers to supply goods, which are manufactured by some other firm, the tenderer has been duly authorized by the goods manufacturer to quote for and supply the goods to BNPM. The tenderer shall submit the manufacturer's authorization letter to this effect as per the standard form provided under Volume I in this document.
- b) The tenderer has the required financial, technical and production capability necessary to perform the contract and, further it meets the qualification criteria incorporated in the Volume I in these documents.
- c) In case the tenderer is not doing business in India, It is/will be duly represented by an agent stationed in India fully equipped and able to carry out the required contractual functions and duties of the supplier including after sale service, maintenance & repair etc. of the goods in question, stocking of spare parts and fast moving components and other obligations, if any, specified in the conditions of contract and/ or technical specifications.
- d) In case the tenderer is an Indian agent quoting on behalf of a foreign manufacturer, the Indian agent is already enlisted under the Compulsory Enlistment Scheme of Ministry of Finance. Govt. of India operated through Directorate General of Supplies & Disposals (DGS&D), New Delhi.
- 17. Documents establishing good's Conformity to Tender document**
- 17.1. The tenderer shall provide in its tender the required as well as the relevant documents like technical data. Literature, drawings etc. to establish that the goods and services offered in the tender fully conform to the goods and services specified by BNPM in the tender documents. For this purpose the tenderer shall also provide a clause-by-clause commentary on the technical specifications and other technical details incorporated by BNPM in the tender documents to establish technical responsiveness of the goods and services offered in its tender.
- 17.2. In case there is any variation and/ or deviation between the goods & services prescribed by BNPM and that offered by the tenderer, the tenderer shall list out the same in "Schedule of deviations from Technical specifications" in Volume I of the tender without ambiguity along with justification.
- 17.3. If a tenderer furnishes wrong and/ or misguiding data, statement(s) etc. about technical acceptability of the goods and services offered by it, its tender will be liable to be ignored and rejected in addition to other remedies available to BNPM in this regard.
- 18. Earnest Money Deposit (EMD)-Not applicable**
- 18.1. Pursuant to GIT clause 10.1(d) the tenderer shall furnish along with its tender, earnest money for amount as shown in the List of Requirements/NIT Clause I. The earnest money is required to protect BNPM against the risk of the tenderer's unwarranted conduct as amplified under sub-clause 23.23.2 below.
- 18.2. The earnest money shall be denominated in Indian Rupees.
- 18.3. The earnest money shall be furnished in one of the following forms:
- a) Account Payee Demand Draft or
- b) Banker's cheque or
- c) Bank Guarantee, (only if EMD amount is above Rs. 1 Lakh)
- 18.4. The demand draft or banker's cheque shall be drawn on any scheduled commercial bank in India, in favour of Bank Note paper Mill India Private Limited payable at Bangalore. In case of bank guarantee, the same is to be provided from/confirmed by any scheduled commercial bank in India as per the format specified in Volume I in these documents.
- 18.5. The earnest money shall be valid for a period of forty five days beyond the validity period of the tender.
- 18.6. Unsuccessful tenderers' earnest money will be returned to them without any interest, after expiry of the tender validity period, but not later than thirty days after conclusion of the resultant contract. Successful tenderer's earnest money will be returned without any interest, after receipt of performance security from that tenderer.
- 18.7. Earnest money of a tenderer will be forfeited, if the tenderer withdraws or amends its tender or impairs or derogates from the tender in any respect within the period of validity of its tender. The successful tenderer's earnest money will be forfeited if it fails to furnish the required performance security within the specified period.
- 19. Tender Validity**
- 19.1. If not mentioned otherwise in the SIT, the tenders shall remain valid for acceptance for a period of 90 days (Ninety days) in case of single bid tender system and 120 days in case of two-bid system after the date of tender opening prescribed in the tender document. Any tender valid for a shorter period shall be treated as unresponsive and rejected.
- 19.2. In exceptional cases, the tenderers may be requested by BNPM to extend the validity of their tenders up to a specified period. Such request(s) and responses thereto shall be conveyed by surface mail or by fax/email/ telex/cable followed by surface mail. The tenderers, who agree to extend the tender validity, are to extend the same without any change or modification of their original tender and they are also to extend the validity period of the EMD accordingly.
- 19.3. In case the day up to which the tenders are to remain valid falls on/subsequently declared a holiday or closed day for BNPM, the tender validity shall automatically be extended up to the next working day.
- 19.4. Compliance with the Clauses of this Tender Document: Tenderer must comply with all the clauses of this Tender Document. In case there are any deviations, these should be listed in a chart form without any ambiguity along with justification.
- 20. Signing and Sealing of Tender**
- 20.1. An authenticated copy of the document which authorizes the signatory to commit on behalf of the firm shall accompany the offer. The individual signing the tender or any other documents connected therewith should clearly indicate his full name and designation and also specify whether he is signing,
- a) As Sole Proprietor of the concern or as attorney of the Sole Proprietor;
- b) As Partner (s) of the firm;
- c) As Director, Manager or Secretary in case the of Limited Company duly authorized by a resolution passed by the Board of Directors or in pursuance of the Authority conferred by Memorandum of Association.
- 20.2. The authorized signatory of the tenderer must sign the tender at appropriate places and initial the remaining pages of the tender.
- 20.3. The tenderers shall submit their tenders as per the instructions contained in GIT Clause 10.
- 20.4. Unless otherwise mentioned in the SIT, a tenderer shall submit two copies of its tender marking them as "Original and "Duplicate".
- 20.5. The original and other copies of the tender shall either be typed or written in indelible ink and the same shall be signed by the tenderer or by a person(s) who has been duly authorized to bind the tenderer to the contract. The letter of authorization shall be by a written power of attorney, which shall also be furnished along with the tender.

SECTION II – GENERAL INSTRUCTIONS TO TENDERES

- 20.6. All the copies of the tender shall be duly signed at the appropriate places as indicated in the tender documents and all other pages of the tender including printed literature, if any shall be initialled by the same person(s) signing the tender. The tender shall not contain any erasure or overwriting, except as necessary to correct any error made by the tenderer and, if there is any such correction; the same shall be initialled by the person(s) signing the tender.
- 20.7. The tenderer is to seal the original and each copy of the tender in separate envelopes, duly marking the same as "Original", "Duplicate" and so on and writing the address of BNPM and the tender reference number on the envelopes. The sentence "NOT TO BE OPENED before (The tenderer is to put the date & time of tender opening) are to be written on these envelopes. The inner envelopes are then to be put in a bigger outer envelope, which will also be duly sealed, marked etc. as above. If the outer envelope is not sealed and marked properly as above, BNPM will not assume any responsibility for its misplacement, premature opening, late opening etc.
- 20.8. For purchasing capital equipment, high value plant, machinery etc. of complex and technical nature, tender document will seek quotation in two parts (Two Bid System)- first part containing the relevant technical details of the equipment/machinery etc., and in the second part, price quotation along with other allied issues. First part will be known as 'Technical Bid', and the second part 'Financial bid'. Tenderer shall seal separately 'Technical Bid' and 'Financial bid' and covers will be suitably super scribed. Both these sealed covers shall be put in a bigger cover and sealed and evaluation would be done as described in clause 25.24.4 below. Further details would be given in SIT, if considered necessary.
- 20.9. If permitted in the SIT, the tenderer may submit its tender through a-tendering procedure.

D. Submission of Tenders

21. Submission of Tenders

- 21.1. Unless otherwise specified, the tenderers are to deposit the tenders in the tender box kept for this purpose at a place as indicated in para 1 of NIT. In case of bulky tender, which cannot be put into tender box, the same shall be submitted by the tenderer by hand to the designated officers of BNPM, as indicated in clause 1 of NIT. The officer receiving the tender will give the tenderer an official receipt duly signed with date and time.
- 21.2. The tenderers must ensure that they deposit their tenders not later than the closing time and date specified for submission of tenders. In the event of the specified date for submission of tender falls on/is subsequently declared a holiday or closed day for BNPM, the tenders will be received up to the appointed time on the next working day.

22. Late Tender

A tender, which is received after the specified date and time for receipt of tenders will be treated as "late" tender and will be ignored.

23. Alteration and Withdrawal of Tender

- 23.1. The tenderer, after submitting its tender, is permitted to alter/modify its tender so long as such alterations/modifications are received duly signed, sealed and marked like the original tender, within the deadline for submission of tenders. Alterations/modifications to tenders received after the prescribed deadline will not be considered.
- 23.2. No tender should be withdrawn after the dead line for submission of tender and before expiry of the tender validity period. If a tenderer withdraws the tender during this period, it will result in forfeiture of the earnest money furnished by the tenderer in its tender besides other sanctions by BNPM.

E. TENDER OPENING

24. Opening of Tenders

- 24.1. The tenders will be opened at the specified date and time and at the specified place as indicated in clause 1 of NIT. In case the specified date of tender opening falls on/is subsequently declared a holiday or closed day for BNPM, the tenders will be opened at the appointed time and place on the next working day.
- 24.2. Authorized representatives of the tenderers, who have submitted tenders on time may attend the tender opening, provided they bring with them letters of authority as per the format in Volume I of the corresponding tenderers. The tender opening official(s) will prepare a list of the representatives attending the tender opening. The list will contain the representatives' names & signatures and corresponding tenderers' names and addresses.
- 24.3. During the tender opening, the tender opening official(s) will read the salient features of the tenders like description of the goods offered, price, special discount if any, delivery period, whether earnest money furnished or not and any other special features of the tenders, as deemed fit by the tender opening official(s).
- 24.4. In-case of two bid system mentioned in clause 20.8 above, the technical bids are to be opened in the first instance, at the prescribed time and date. These bids shall be scrutinized and evaluated by the competent committee/ authority with reference to parameters prescribed in the tender document. Thereafter, in the second stage, the financial bids of only the technically acceptable offers (as decided in the first stage) shall be opened for further scrutiny and evaluation. Other financial bids would be returned unopened to the respective bidders under Registered AD/ Reliable Courier or any other mode with proof of delivery.

F. SCRUTINY AND EVALUATION OF TENDERS

25. Basic Principle

Tenders will be evaluated on the basis of the terms & conditions already incorporated in the tender document, based on which tenders have been received and the terms, conditions etc. mentioned by the tenderers in their tenders. No new condition will be brought in while scrutinizing and evaluating the tenders.

26. Preliminary Scrutiny of Tenders

- 26.1. The tenders will first be scrutinized to determine whether they are complete and meet the essential and important requirements, conditions etc. as prescribed in the tender document. The tenders, that do not meet the basic requirements, are liable to be treated as unresponsive and ignored.
- 26.2. The following are some of the important aspects, for which a tender may be declared unresponsive and ignored;
- Tender is unsigned.
 - Tenderer is not eligible.
 - Tender validity is shorter than the required period.
 - Required EMD has not been provided.
 - Tenderer has quoted for goods manufactured by a different firm without the required authority letter from that manufacturer.
 - Tenderer has not agreed to give the required performance security.
 - Goods offered are not meeting the required specification etc.
 - Tenderer has not agreed to essential condition(s) specially incorporated in the tender enquiry.
 - Against a schedule in the List of Requirement (incorporated in the tender Enquiry), the Tenderer has not quoted for the entire requirement as specified in that schedule. (Example: In a schedule, it has been stipulated that the Tenderer will supply the equipment, install and commission it and also train BNPM's operators for operating the equipment. The Tenderer has however, quoted only for supply of the equipment).

27. Minor Infirmary/Irregularity/ Non-Conformity

If during the preliminary examination, BNPM find any minor infirmity and/ or irregularity and/ or non-conformity in a

SECTION II – GENERAL INSTRUCTIONS TO TENDERES

tender, BNPM may waive the same provided it does not constitute any material deviation and financial impact and, also, does not prejudice or affect the ranking order of the tenderers. Wherever necessary, BNPM will convey its observation on such 'minor' issues to the tenderer by registered/ speed post etc. asking the tenderer to respond by a specified date. If the tenderer does not reply by the specified date or gives evasive reply without clarifying the point at issue in clear terms, that tender will be liable to be ignored.

28. Discrepancy in Prices

- 28.1. If, in the price structure quoted by a tenderer, there is discrepancy between the unit price and the total price (which is obtained by multiplying the unit price by the quantity), the unit price shall prevail and the total price corrected accordingly, unless BNPM feels that the tenderer has made a mistake in placing the decimal point in the unit price, in which case the total price as quoted shall prevail over the unit price and the unit price corrected accordingly.
- 28.2. If there is an error in a total price, which has been worked out through addition and/ or subtraction of subtotals, the subtotals shall prevail and the total corrected; and
- 28.3. If there is a discrepancy between the amount expressed in words and figures, the amount in words shall prevail, subject to sub clause 28.1 and 28.2 above.
- 28.4. If, as per the judgment of BNPM, there is any such arithmetical discrepancy in a tender, the same will be suitably conveyed to the tenderer by registered/speed post. If the tenderer does not agree to the observation of BNPM, the tender is liable to be ignored.

29. Discrepancy between original and copies of Tender

In case any discrepancy is observed between the text etc. of the original copy and that in the other copies of the same tender set, the text etc. of the original copy shall prevail. Here also, BNPM will convey its observation suitably to the tenderer by register/speed post and, if the tenderer does not accept BNPM's observation, that tender will be liable to be ignored.

30. Clarification of Bids

During evaluation and comparison of bids, purchaser may, at its discretion ask the bidder for clarification of its bid. The clarification should be received within 7 days from the bidder from date of receipt of such request. The request for clarification shall be in writing and no change in prices or substance of the bid shall be sought, offered or permitted. No post bid clarification at the initiative of the bidder shall be entertained.

31. Qualification/ Eligibility Criteria

Tenders of the tenderers, who do not meet the required qualification/eligibility criteria prescribed in Section IX, will be treated as unresponsive and will not be considered further.

32. Conversion of tender currencies to Indian Rupees

In case the tender document permits the tenderers to quote their prices in different currencies, all such quoted prices of the responsive tenderers will be converted to a single currency viz., Indian Rupees for the purpose of equitable comparison and evaluation, as per the B.C. selling exchange rates established by the State Bank of India for similar transactions, as on the date of tender opening.

33. Schedule-wise Evaluation

In case the List of Requirements contains more than one schedule, the responsive tenders will be evaluated and compared separately for each schedule. The tender for a schedule will not be considered if the complete requirements prescribed in that schedule are not included in the tender. However, as already mentioned in GIT sub clause 12.2, tenderers have the option to quote for any one or more schedules and offer discounts for combined schedules. Such discounts, wherever applicable, will be taken into account to

determine the tender or combination of tenders offering the lowest evaluated cost for BNPM in deciding the successful tenderer for each schedule, subject to that tenderer(s) being responsive.

34. Comparison on CIF Destination Basis

Unless mentioned otherwise in Volume I - Special Instructions to Tenderers and List of Requirements, the comparison of the responsive tenders shall be on CIF destination basis, duly delivered, commissioned, etc. as the case may be.

35. Additional Factors and Parameters for Evaluation and Ranking of Responsive Tenders.

35.1. Further to GIT Clause 33 above, BNPM's evaluation of a tender will include and take into account the following:

- In the case of goods manufactured in India or goods of foreign origin already located in India, sales tax & other similar taxes and excise duty & other similar duties, which will be contractually payable (to the tenderer), on the goods if a contract is awarded on the tenderer; and
- In the case of goods of foreign origin offered from abroad, customs duty and other similar import duties/taxes, which will be contractually payable (to the tenderer) on the goods if the contract is awarded on the tenderer.

35.2. BNPM's evaluation of tender will also take into account the additional factors, if any, incorporated in SIT in the manner and to the extent indicated therein.

35.3. As per policies of the Government from time to time, the purchaser reserves its option to give price preference to Small Scale Industries in comparison to the large scale Industries. This price preference cannot however be taken for granted and every endeavour need to be made by such firms to bring down cost and achieve competitiveness.

35.4. If the tenders have been invited on variable price basis, the tenders will be evaluated, compared and ranked on the basis of the position as prevailing on the day of tender opening and not on the basis of any future date.

36. Tenderer's capability to perform the contract

36.1. BNPM, through the above process of tender scrutiny and tender evaluation will determine to its satisfaction whether the tenderer, whose tender has been determined as the lowest evaluated responsive tender is eligible, qualified and capable in all respects to perform the contract satisfactorily. If, there is more than one schedule in the List of Requirements, then, such determination will be made separately for each schedule.

36.2. The above mentioned determination will, inter-alia, take into account the tenderer's financial, technical and production capabilities for satisfying all the requirements of BNPM as incorporated in the tender document. Such determination will be based upon scrutiny and examination of all relevant data and details submitted by the tenderer in its tender as well as such other allied information as deemed appropriate by BNPM.

37. Cartel Formation (Pool Rates)

Cartel formation or quotation of Pool/ Co-ordinated rates, leading to "Appreciable Adverse Effect on Competition" (AAEC) as identified in Competition Act, 2002, as amended by Competition (Amendment) Act, 2007, would be considered as a serious misdemeanour and would be dealt accordingly as per Clause 44 below.

38. Negotiations

Normally there would be no price negotiations. But BNPM reserves its right to negotiate with the lowest acceptable bidder (L1), who is technically cleared /approved for supply of bulk quantity and on whom the contract would have been placed but for the decision to negotiate, under special circumstances in accordance with prevailing guidelines.

39. Contacting BNPM

39.1. From the time of submission of tender to the time of awarding the contract, if a tenderer needs to contact BNPM for any reason relating to this tender enquiry and/or its tender it should do so only in writing.

39.2. It will be treated as a serious misdemeanour in

SECTION II – GENERAL INSTRUCTIONS TO TENDERES

case a tenderer attempts to influence BNPM's decision on scrutiny, comparison, evaluation and award of the contracts. In such a case the tenderer shall be liable for rejection in addition to appropriate administrative actions being taken against that tenderer, as deemed fit by BNPM, in terms of clause 44 of GIT.

G. Award Of Contract

40. BNPM reserves the right to accept any Tender and to reject any or all Tenders. BNPM also reserves the right to accept in part or in full any tender or reject any tender without assigning any reason or to cancel the tendering process and reject all tenders at any time prior to award of contract, without incurring any liability, whatsoever to the affected tenderer or tenderers.

41. Award Criteria

Subject to GIT clause 36 above, the contract will be awarded to the lowest evaluated responsive tenderer decided by BNPM in terms of GIT Clause 34.

42. Variation of Quantities at the Time of Award

No variation of quantities at the time of awarding the contract.

43. Parallel Contracts

BNPM reserves its right to conclude Parallel contracts with more than one bidder (for the same tender). If this is foreseen at the time of Tendering, a clause would be included in SIT giving further details.

44. Serious Misdemeanours

44.1 Following would be considered serious misdemeanours:

- a) Submission of misleading/ false/ fraudulent information/ documents by the bidder in their bid
- b) Submission of fraudulent / un-encashable Financial Instruments stipulated under Tender or Contract Condition.
- c) Violation of Code of Ethics laid down in Clause 32 of the GCC.
- d) Cartel formation or quotation of Pool/ Co-ordinated rates leading to "Appreciable Adverse Effect on Competition" (AAEC) as identified under the Competition Act, 2002.
- e) Deliberate attempts to pass off inferior goods or short quantities.
- f) Violation of Fall Clause by Rate Contract holding Firms.
- g) Attempts to influence BNPM's Decisions on scrutiny, comparison, evaluation and award of Tender.

44.2 Besides, suitable administrative actions, like rejecting the offers or delisting of registered firms, BNPM would ban/blacklist Tenderers committing such misdemeanour, including declaring them ineligible to be awarded BNPM contracts for indefinite or for a stated period.

45. Notification of Award

45.1 Before expiry of the tender validity period, BNPM will notify the successful tenderer(s) in writing, by registered/speed post or by fax/email / telex/ cable (to be confirmed by registered/speed post that its tender for goods & services, which have been selected by BNPM, has been accepted, also briefly indicating therein the essential details like description, specification and quantity of the goods & services and corresponding prices accepted. The successful tenderer must furnish to BNPM the required performance security within twenty one days from the date of this notification. Relevant details about the performance security have been provided under GCC Clause 6 under Section IV.

45.2 The notification of award shall constitute the conclusion of the contract.

46. Issue of Contract

46.1 Within seven working days of receipt of performance security, BNPM will send the contract form (as per Section XVI) duly completed and signed, in duplicate, to the

46.2 successful tenderer by registered / speed post. Within seven days from the date of issue of the contract, the successful tenderer will return the original copy of the contract, duly signed and dated, to BNPM by registered / speed post.

47. Non-receipt of Performance Security and Contract by BNPM

Failure of the successful tenderer in providing performance security within 21 days of receipt of notification of award and/or returning contract copy duly signed in terms of GIT clauses 45 and 46 above shall make the tenderer liable for forfeiture of its EMD and, also for further sanctions by BNPM against it.

48. Return of EMD

Earnest money of the successful tenderer and the unsuccessful tenderers will be returned to them without any interest, whatsoever, in terms of GIT Clause 18.6.

49. Publication of Tender Result

The name and address of the successful tenderer(s) receiving the contract(s) will be mentioned in the web site of BNPM.

PART II: ADDITIONAL GENERAL INSTRUCTIONS APPLICABLE TO SPECIFIC TYPES OF TENDERS

50. Rate Contract Tenders

50.1 In addition to GIT in Part I above, following GIT will be applicable to rate contract Tenders:

- a) Earnest Money Deposit (EMD) is not applicable.
- b) In the Schedule of Requirement, no commitment of quantity is mentioned: only the anticipated requirement is mentioned without any commitment.
- c) BNPM reserves the right to conclude more than one rate contract for the same item.
- d) Unless otherwise specified in SIT, the currency of a Rate Contract would normally be for one year.
- e) During the currency of the Rate Contract, BNPM may withdraw the rate contract by serving suitable notice. The prescribed notice period is generally thirty days.
- f) During the currency of the Rate Contract, BNPM would have the option to renegotiate the price with the rate contract holders.
- g) During the currency of the Rate Contract, in case of emergency, BNPM may purchase the same item through ad hoc contract with a new supplier.
- h) Usually, the terms of delivery in rate contracts are FOR dispatching station.
- i) Supply orders, incorporating definite quantity of goods to be supplied along with all other required conditions following the rate contract terms, will be issued by nominated Direct Demanding Officers (DDO) for obtaining supplies through the rate contract.
- j) BNPM is entitled to place supply orders up to the last day of the validity of the rate contract and, though supplies against such supply orders will be affected beyond the validity period of the rate contract, all such supply will be guided by the terms & conditions of the rate contract.
- k) The rate contract will be guided by "Fall Clause" as described below.

50.2 Fall Clause

If the rate contract holder reduces its price or sells or even offers to sell the rate contracted goods, following conditions of sale similar to those of the rate contract, at a price lower than the rate contract price, to any person or organization during the currency of the rate contract, the rate contract price will be automatically reduced with effect from that date for all the subsequent supplies under the rate contract and the rate contract amended accordingly. Any violation of the fall clause would be considered a serious misdemeanour under clause 44 of the GIT and action, as appropriate, would be taken as per provision of that clause.

50.3 Performance Security

Value of Performance Security would be stipulated in the SIT. Performance Security shall, however, not be demanded again in the individual supply orders issued subsequently against rate contracts.

SECTION II – GENERAL INSTRUCTIONS TO TENDERES

- 50.4 Renewal of Rate Contracts
In case, it is not possible to conclude new rate contracts before the expiry of existing ones, due to some special reasons, the existing rate contracts would be extended with same terms, conditions etc. for a suitable period, with the consent of the rate contract holders. Rate contracts of the firms, who do not agree to such extension, will be left out. Period of such extension would generally not be more than three months.
- 51. Prequalification Bidding**
- 51.1 Prequalification bidding is for short-listing of qualified Bidders who fulfil the Prequalification criteria as laid down in SIT or in Volume I of SBD - "Qualification Criteria" for procurement of Goods or Services as listed in Section VI of SBD - "List of Requirements". Shortlisted Bidders would be informed of their qualification and short listing in accordance with the stipulations laid down in the SIT Unless otherwise stipulated in the SIT the PQB short listing would be valid only till the next procurement tender. Further conditions will be elaborated in the SIT.
- 51.2 If stipulated in the SIT, only these shortlisted qualified bidders would be invited to participate in the Procurement process. Otherwise SIT may also indicate that instead of floating a separate PQB tender, it may be combined with the Procurement Tender, as a three bid tender. Initially the first Packet containing PQB would be opened and evaluation would be done. Thereafter the rest of tender would be handled as a two bid system for only those bidders who succeed in PQB.
- 52. Tenders involving Samples**
- 52.1 Normally no sample would be called along with the offer for evaluation.
- 52.2 Purchaser's Samples:
If indicated in the SIT, A Purchaser's sample may be displayed to indicate required characteristics over and above the Specifications for perusal of the bidders Name and Designation of the Custodian, Place, Dates and Time of inspection of Purchaser's sample will be indicated in the SIT. The supplies in the contract will have to meet the indicated required characteristics for which the Purchaser's sample was displayed, besides meeting the specification listed in "Technical Specifications" of the Tender. He would be issued a sealed Purchaser's sample for the purpose at the time of award of the contract.
- 52.3 Pre-Production Samples:
If stipulated in SIT, successful contractor would be required to submit a Pre-Production sample(s) to the Inspecting Officer/ or the nominated authority mentioned in the contract within the time specified therein. If the Contractor is unable to do so, he must apply immediately to the Office issuing the acceptance of tender for extension of time stating the reasons for the delay. If the Purchaser is satisfied that a reasonable ground for an extension of time exists, he may allow such additional time as he considers to be justified (and his decision shall be final) with or without alteration in the delivery period stipulated in the contract and on such conditions as he deems fit. In the event of the failure of the Contractor to deliver the pre-production sample by the date specified in the acceptance of tender or any other date to which the time may be extended as aforesaid by the Purchaser or of the rejection of the sample, the Purchaser shall be entitled to cancel the contract and, if so desired, purchase or authorize the purchase of the stores at the risk and cost of the Contractor (unless specified otherwise in the SIT). In such an event, in case of Security Items where urgency develops due to such delays, BNPM reserves its right to procure not more than one year's requirement against this "Risk & Cost" tender from existing pre-qualified and security cleared firms. Bulk production and supply will only be allowed if this sample(s) pass the Tests laid down in the "Quality Control Requirements" of Volume I.
- 52.4 Testing of Samples
Tests, procedures and testing laboratories for testing samples would be detailed in the Section VIII- "Quality Control Requirements" in the SBD.
- 52.5 Validation/ Prolonged Trials
If specified in SIT or in the Section VIII- "Quality Control Requirements" in the SBD, pre-production samples may have to undergo validation or extended trial before their performance can be declared satisfactory.
- 52.6 Parameters Settings and duration of Validation Tests would be indicated in Volume I - "Quality Control Requirements". It would also stipulate the period or event marking end of validation trials. It would also be indicated therein whether the Permission to start bulk production will have to wait full validation or it can go on in parallel.
- 53. Expression of Interest (EOI) Tenders: NOT APPLICABLE**
- 53.1 EOI tenders are floated for short listing firms who are willing and qualified for: -
- a) Registration of Vendors for Supply of particular Stores or certain categories of Stores.
- b) Development of new items or indigenization of Imported stores
- 53.2 The qualification /eligibility criteria required and the format of submission of such Data would be indicated in the "Qualification Criteria" of Volume I.
- 53.3 Objectives and scope of requirement would be indicated in the Section VI - "List of Requirements" in the SBD. Indicative quantity required yearly and its future requirements would also be indicated.
- 53.4 In case of EOI for Development of new Items or for indigenization, prospective firms would be given opportunity to inspect the Machine/ Item at the place of installation at the place, dates and time mentioned in SIT.
- 53.5 In case EOI is for registration of vendors, Registration Fees and validity period of registration would be detailed in the SIT.
- 53.6 Short List of Suppliers: The suppliers shall be evaluated for short listing, inter-alia, based on their past experience of supplying goods in similar context, financial strength, technical capabilities etc. Each supplier will be assigned scores based on weightages assigned to each of the criteria mentioned in the "Qualification Criteria" in Volume I.
- 53.7 If stipulated in the SIT, the Firm's capacity and Capability may be assessed by a nominated Committee or by a third party nominated by BNPM.
- 53.8 All suppliers who secure the minimum required marks (normally 50% unless otherwise specified in the "Qualification Criteria" in Volume I) would be short listed. "Qualification Criteria" may alternatively specify minimum qualifying requirement for each of the criteria i.e. minimum years of experience, minimum number of assignments executed, minimum turnover etc. Under such circumstances, all suppliers who meet the minimum requirement, as specified, will be short listed.
- 53.9 In case of EOI for registration of vendors, registration letters would be issued to the shortlisted tenderers.
- 53.10 In case of EOI for development/ indigenization, these shortlisted tenderers would only be allowed to participate in the subsequent development/ indigenization tenders.
- 54. Tenders for Disposal of Scrap: NOT APPLICABLE**
- 54.1 Introduction:**
The tender is for Sale of Scrap material lying at various locations. Details of scrap for sale including Description, Present Condition, Lot Size and its Location would be given in the Section VI -"List of Requirements".
- 54.2 "As Is; Where Is; Whatever Is" Basis of This Sale:
54.2.1 This sale of Scrap is strictly on "As Is; Where Is; Whatever Is" basis. Tenderer must satisfy himself on all matters with regard to quality, quantity; nature of stores etc., before tendering as no complaint or representation of any kind shall be entertained after the sale contract is concluded.
- 54.2.2 The description of lot in the particulars of sale has been given for the purpose of identification thereof only and the use of such description shall not constitute the sale thereof to be sale by description and no sale shall be invalid by reason of any defect or deviation or variation in any lot or on account

SECTION II – GENERAL INSTRUCTIONS TO TENDERES

- of any lot not being exactly described and the purchaser shall not be entitled to claim any damage or compensation whatsoever on account of such fault, error in description, weight or the like.
- 54.2.3 All quantities of scrap whether by weight or measurement mentioned in the Tender notice are only approximate and should the quantity, on actual weight or measurement basis as the case may be and whenever delivered on such basis, works out less than the advertised and /or projected quantity, the BNPM shall not under any circumstances be liable to make good any such deficiency
- 54.2.4 BNPM reserves right to increase or decrease the quantity of any item or items or terminate the contract at any stage by giving one week's notice. No claim whatsoever shall lie against the BNPM on account of such termination of the contract or variation in the quantity.
- 54.2.5 BNPM shall have the right to remove certain items which it feels were not intended for sale but were inadvertently made a part of the scrap material or of the lot offered for sale lying at the premises or were joined or attached to the material offered for sale.
- 54.2.6 Tenderers desirous of purchasing and participating in the tender must visit the site before submitting the offer, after taking due permission from the concerned Stock Holders. The Tenderers submitting the offers shall be deemed to have visited the site and acquainted themselves thoroughly with materials intended for sale in all respect.
- 54.2.7 Any person giving offer shall be deemed to have made himself fully conversant with the Terms and Conditions of the Tender Sale, as well as the location and condition of the materials being sold and shall be deemed to have agreed to all the stated terms and conditions herein under.
- 54.3 **Submission of Offer:**
- 54.3.1 Unless specified otherwise in the SIT, tenders shall hold good for acceptance for a minimum period of 90 days (ninety days) from the date of opening of the tenders. The offers of the tenderers shall be irrevocable.
- 54.3.2 BNPM reserves right to reject any offer without assigning any reason therefore.
- 54.3.3 Unless otherwise stated in the SIT, the amount of EMD in such tenders would be 5% of the value of the tender. The Earnest Money shall be forfeited if the tenderer unilaterally withdraws, amends, impairs or derogates from his offer in any respect within the period of validity of his offer.
- 54.3.4 If the offer of the tenderer is not accepted by the BNPM, the Earnest Money deposit made by the tenderer shall be refunded to him. No interest shall be payable on such refunds. The EMD deposited by the successful tenderer shall remain with the BNPM till payment of the security deposit (SO) money, as stipulated in relevant Clause, has been made. It may be adjusted as part of the total SO money at the discretion of the BNPM.
- 54.3.5 Commercial tax/terminal tax, Octroi, municipal tax or any other taxes/duties etc. whatever in force shall be payable extra by the purchaser as per rules applicable to BNPM. Current and valid PAN and sales/commercial tax registration number wherever applicable must be provided in the Bid of the Tenderer.
- 54.3.6 All arrangement for lifting and transportation of scrap material, including manpower, crane, transport vehicle and trolley etc., if required shall be made by the purchaser concerned only and the BNPM shall not provide or help in providing any such arrangements and the rate quoted by the purchaser must include such and all incidental charges.
- 54.3.7 Registered dealers who are exempted from payment of Sales Tax must submit copies of their Registration certificate of concerned authority and shall be required to submit necessary form duly completed in all respect to BNPM or its
- 55.8 If specified in SIT, Advance and Intermediate Payment to Suppliers may be allowed.
- 55.9 Quantity for Development Commitment
- In Next three years, after the newly developed firm is able to successfully complete Development orders with +/-5% tolerance, 20% of annual quantity requirement may be reserved for Newly Developed firms.
- 54.3.8 representatives before obtaining delivery order, duly signed by the partner of the firm or the person authorized to do so. Evaluation of tenders for Disposal of scrap will be done on similar basis as Tenders for Procurement of Goods, except that the selection of the bidders shall be on the basis of the highest responsive Bidder (H1). In case full quantity is not offered to be taken by the Highest Bidder, parallel contracts would be placed.
- 54.4 Notification of Acceptance and Award of Contract:
- 54.4.1 The successful tenderer, herein after referred to as purchasers, shall have to submit security deposit (SO) @ 10% of the total sale value of the contract within 5 working days of issue of the sale contract (excluding the date of issue of sale contract). The SO shall be deposited in the form of bank draft/pay order, drawn on any nationalized or recognized bank in favour of same officer as mentioned in clause 3 of NIT in connection with EMD. The purchaser has to pay balance payment within 20 days from the date of notification of acceptance, which is to be issued by BNPM or his authorized representative, in form of Bank draft drawn on any nationalized or recognized bank in favour of same authority as mentioned above. In case of any, default to deposit balance payment, BNPM reserves right to terminate the contract and forfeit the security deposit.
- 54.4.2 Disposal Tenders for Security and Sensitive Machinery and Items:
- 54.5 Non-Misuse Declaration: The bidder is required to give an undertaking that he or his employees or legal heirs will ensure that such items purchased from BNPM, will be utilized only for scrap recovery and will not be misused for any other purpose. He will also ensure that this undertaking is honoured and it got underwritten from further down the line scrap processors/ repurchasers, if any. In case his firm changes hands, it will be his responsibility to ensure that the new owners honour and underwrite this undertaking.
- 54.5.2 If stipulated in SIT delivery would be given only in dis-mantled/ cut-up condition.
55. **Development and indigenization Tenders: NOT APPLICABLE**
- 55.1 Already developed firms or firms who have already received development orders for the item (with whatever results) would not be considered in such tenders.
- 55.2 If specified in SIT the tender documents may be issued free of cost, and submission of earnest money deposit and security deposit may be relaxed.
- 55.3 If specified in SIT, The Tenderers may quote separately for
- a) Price/rate for bulk supply of item in development/indigenization supplies and
- b) Separately, cost of development including cost of pre-production samples. Firms would be paid only for the number of samples specified in the Tender. If he has to manufacture more samples due to failure of earlier one, he would not be paid for it.
- 55.4 L1 would be determined on the basis of rate of item quoted including reference to total cost of the development cost (including the cost of prototype) plus the notional total cost of quantities that will be required over next three years, wherever applicable.
- 55.5 Development contracts may, as far as feasible, be concluded with two or more contractors in parallel.
- 55.6 The ratio of splitting of the supply order between various development agencies/firms in cases of parallel development, including criteria thereof, would be specified in the SIT.
- 55.7 However, in case the requirement is meagre and complex technology is involved, or quantity of the equipment spares is limited/small/uneconomic if distributed between two vendors, the entire order could be placed upon the L1 vendor only.
- 55.10 Period of Development Commitment
- A newly developed firm would be granted this facility till only three years after completing the initial Development order. However this facility is not a bar to the firm from competing with already established firms for quantities larger than 20% provided their prices and performance so warrant. Thereafter they would have to compete on equal terms with other already developed firms.

SECTION III – SPECIAL INSTRUCTIONS TO TENDERES

The following Special Instructions to Tenderers will apply for this purchase. These special instructions will modify/ substitute/ supplement the corresponding General Instructions to Tenderers (GIT) incorporated in Section II. The corresponding GIT clause numbers have also been indicated in the text below:

In case of any conflict between the provision in the GIT and that in the SIT, the provision contained in the SIT shall prevail.

(Clauses of GIT listed below include a possibility for variation in their provisions through SIT. There could be other clauses in SIT as deemed fit.)

Sl. No.	GIT Clause no	Topic	SIT Provision
1	1,2,3,4,5,6, 7	PREAMBLE-Introduction, Language of Tender, Eligible Tenderers, Eligible Goods and Services (Origin of Goods), Tendering Expense, Tender Documents, Amendments to Tender Documents	No Change
2	8	Pre-bid Conference	24.01.2020
3	9	Time Limit for receiving request for clarification of Tender Documents	Should not be later than 10 days prior to prescribed date of submission of tender.
4	10,11,12, 13,14,15	Documents Comprising the Tender, Tender Currencies, Tender Prices, Indian Agent, PVC Clause & Formula, Alternative tenders	No Change except the taxes will be applicable as per GST rules (Clause 12.7 to Clause 12.13)
5	16	Documents Establishing Tenderer's Eligibility and Qualifications	No Change
6	17	Documents establishing Good's Conformity to Tender document	No Change
7	18	Earnest Money Deposit (EMD) Note: Bidders claiming exemption of EMD should submit the DGS&D (or) NSIC registration certificate without fail along with their techno-commercial offer. EMD exemption for DGS&D (or) NSIC registered firm. Cost of tender to be submitted.	Not applicable
8	19	Tender Validity (120 days in case of two-bid system after the date of tender opening prescribed in the tender document)	No Change
9	20	Signing and Sealing of Tender Note: The following SIT provision is made with respect the following clause 20.4. Number of Copies of Tenders to be submitted : NIL 20.9: E procurement: Permitted.	Only – E procurement

SECTION III – SPECIAL INSTRUCTIONS TO TENDERES

10	21,22,23	Submission of Tenders, Late Tender, Alteration and Withdrawal of Tender	No Change
11	24	Opening of tenders Note: Please read the guidelines for filling up two part bid tender as mentioned in NIT above which is described in detail w.r.to clause 24.4	No Change
12	25	Basic Principle	No Change
13	26,27,28, 29,30,31, 32,33,34	Preliminary Scrutiny of Tenders, Minor Infirmary / Irregularity / Non-Conformity, Discrepancy in Prices, Discrepancy between original and copies of Tender, Clarification of Bids, Qualification / Eligibility Criteria, Conversion of tender currencies to Indian Rupees, Schedule-wise Evaluation, Comparison on CIF Destination Basis.	Clause 33: (Refer below Sl. No. 16) No change for other clauses.
14	35 to 49	Additional Factors and Parameters for Evaluation and Ranking of Responsive Tenders, Tenderer's capability to perform the contract, Tenderer's capability to perform the contract, Cartel Formation / Pool Rates, Negotiations, Contacting BNPMIPL, Award of contract, Award Criteria, Variation of Quantities at the Time of Award, Parallel Contracts, Serious Misdemeanors, Notification of Award, Issue of Contract, Non-receipt of Performance Security and Contract by BNPMIPL, Return of EMD, Publication of Tender Result.	Clause 43: (Refer below Sl. No. 17) No change for other clauses.
15	50 to 55	Rate Contract Tenders, PQB Tenders, Tenders involving Purchaser's and Pre-Production Samples, EOI Tenders, Tenders for Disposal of Scrap, Development / Indigenization Tenders	Clause 52: (Refer below Sl. No. 18) No change for other clauses.

16. EVALUATION CRITERIA:

(i) The technical bids shall be opened in the first instance and these bids shall be scrutinised and evaluated by the competent committee/authority with reference to the parameters prescribed in the tender document. Subsequently, in the second stage the financial bids of only technically acceptable offers as decided in first stage shall be opened for further scrutiny and evaluation. Tenderers may check the e-tendering portal (www.tenderwizard.com/BNP) for status of bids.

(ii) All responsive tenderers shall be evaluated as per the terms & conditions of the tender. The basis for arriving at the lowest responsive bidder shall be as per the price quoted for landed cost at Mysore including GST, packing & forwarding charges, freight, insurance and any other charges etc. and input credit shall be deducted to arrive at the effective price. Effective price shall be considered for arriving the lowest responsive bidder.

SECTION III – SPECIAL INSTRUCTIONS TO TENDERES

iii) The method of evaluation of price bid for awarding the Contract shall be on schedule/item wise L1 basis only.

(iv) Bidder has to quote GST rate as per the HSN code provided in Section XI: Price Schedule. In case of any mismatch in HSN code with respect to offered product, same shall be decided in consultation with winning bidder.

17. PARALLEL CONTRACT:

BNPM reserves its rights to conclude Parallel contracts with Three (03) bidders in the ratio 50:30:20 at the L1 quoted price. The bidder firms can quote for the any one or more schedule of tender quantity and the tender would be awarded accordingly, if found L1.

The total quantity may be distributed among Three (03) bidders in the ratio of 50:30:20 between L1, L2 and L3 respectively, at L1 rates only. Counter offers shall be given first to responsive L2 and L3 and so on respectively to match L1 rates. In case L2, L3, L4,.....& so on respectively, do not match with L1 rates, order for entire quantity shall be placed on L1 bidder itself. However, the competent authority would have the discretion to reject tenders above a particular price considered reasonable, though the required quantity may not be available up to the reasonable price.

18. One No. sample Collapsible Plywood Packing Box will be required before opening of Price Bid or as and when indicated by BNPM. Price Bids of only those bidders whose sample boxes are found to be acceptable based on visual inspection, load test e.t.c. and are as per the attached tender specifications, shall be considered for opening (**This clause applicable for new bidders only**).

19. Vendor Performance:-

Vendor shall be evaluated for their performance. The performance shall be based on timeliness of deliveries, quality of the material supplied, technical support, quality of after-sales service if any, replacement of the defective material if any, responsiveness etc.

Based on the above criteria, the vendor shall be rated in category "A", "B" & "C". The vendor with rating "C" shall be disqualified/debarred from participating in the tender for certain period.

20. The Company discourages the engagement of agents for brokering contracts and hence intending bidders are requested to take note of the above that engagement of agents for brokering contracts may result in dis-qualification.

21. The company may verify the production facility of bidders to satisfy itself about the capacity of the bidders as prequalification criteria. Bidders, whose facilities were inspected, have been rated points against criteria mentioned in Section-IX. A combined minimum of 30 points out of a maximum of 50 points are necessary to qualify for price bid opening (**This clause applicable for new bidders only**).

22. All tenderers should be registered under GST. They should be eligible to pass on input credit. Bid will be evaluated all-inclusive, though input credit will be deducted to arrive at the effective cost.

23. Corrigendum/Addendum, if any, shall be hosted on Company's website (www.bnpmindia.com) & e-Tendering portal (www.tenderwizard.com/BNP).

(To be signed & stamped and submitted along with Techno-commercial Bid Part-I)

SECTION IV – GENERAL CONDITIONS OF CONTRACT

PART 1: GENERAL CONDITIONS OF CONTRACT APPLICABLE TO ALL TYPES OF TENDERS

1. Definitions; Interpretation and Abbreviations: In the contract, unless the context otherwise requires:

1.1. Definitions and Interpretation:

i.) "Contract" means the letter or memorandum communicating to the Contractor the acceptance of this tender and includes Intimation of Award" of this tender; "Contract" includes Bid Invitation, Instructions to Tenderers, Tender, Acceptance of Tender, General Conditions of Contract, Schedule of Requirements, particulars and the other conditions specified in the acceptance of tender and includes a repeat order which has been accepted or acted upon by the Contractor and a formal agreement, if executed.

ii.) "Contractor" or "Supplier" means the individual or the firm supplying the goods and services. The term includes his employees, agents, successors, authorized dealers, stockists and distributors. Other homologous terms are: Vendor, Firm, Manufacturer, OEM etc;

iii.) "Drawing" means the drawing or drawings specified in or annexed to the Specifications:

iv.) "Government" means the Central Government or a State Government as the case may be;

v.) The "Inspecting Officer" means the person, or organisation specified in the contract for the purpose of inspection of stores of work under the contract and includes his/his/their authorised representative.

vi.) "Purchase Officer" means the officer signing the acceptance of tender and includes any officer who has authority to execute the relevant contract on behalf of the Purchaser:

vii.) The "Purchaser" means Bank Note Paper Mill India Private Limited (BNPM)- the organization purchasing goods and services as incorporated in the documents

viii.) "Signed" includes stamped, except in the case of an acceptance of tender or any amendment thereof;

ix.) "Test" means such test as is prescribed by the particulars or considered necessary by the Inspecting Officer or any agency acting under the direction of the Inspecting Officer:

x.) The delivery of the stores shall be deemed to have happened on delivery of the stores in accordance with the terms of the contract, after approval by the Inspecting Officer, if so provided in the contract -

a) The consignee at his premises or

b) Where so provided, the interim consignee at his premises or

c) A carrier or other person named in the contract for the purpose of transmission to the consignee or

d) The consignee at the destination station in case of contract stipulating for delivery of stores at destination station.

xi.) "Writing" or "Written" includes matter either in whole or in part in manuscript, typewritten, lithographed, cyclostyled, photographed or printed under or over signature or seal, as the case may be.

xii.) Words in the singular include the plural and vice-versa.

xiii.) Words importing the masculine gender shall be taken to include the feminine gender and words importing persons shall

include any company or association or body of individuals, whether incorporated or not.

xiv.) The heading of these conditions shall not affect the interpretation or construction thereof.

xv.) Terms and expressions not defined herein shall have the meanings assigned to them in the Indian Sale of Goods Act, 1930 (as amended) or the Indian Contract Act, 1872 (as amended) or the General Clauses Act, 1897 (as amended) as the case may be.

xvi.) PARTIES: The parties to the contract are the "Contractor" and the "Purchaser", as defined above;

xvii.) "Tender" means quotation/bid received from a firm/supplier.

xviii.) "Goods" means the articles, material, commodities, livestock, furniture, fixtures, raw material, spares, instruments, machinery, equipment, industrial plant etc. which the supplier is required to supply to BNPM under the contract. Other homologous terms are: Stores, Materials etc.

xix.) "Services" means services allied and incidental to the supply of goods, such as transportation, installation, commissioning, provision of technical assistance, training, after sales service, maintenance service and other such obligations of the supplier covered under the contract.

xx.) "Earnest Money Deposit" (EMD) means monetary guarantee to be furnished by a Tenderer along with its tender

xxi.) "Performance Security" means monetary guarantee to be furnished by the successful Tenderer for due performance of the contract placed on it. Performance Security is also known as Security Deposit or Performance Bank Guarantee.

xxii.) "Consignee" means the person to whom the goods are required to be delivered as specified in the Contract. If the goods are required to be delivered to a person as an interim consignee for the purpose of dispatch to another person as provided in the Contract then that "another" person is the consignee, also known as ultimate consignee.

xxiii.) "Specification" or "Technical Specification" means the drawing/ document/ standard that prescribes the requirement to which product or service has to conform.

xxiv.) "Inspection" means activities such as measuring, examining, testing, analysing, gauging one or more characteristics of the product or service and comparing the same with the specified requirement to determine conformity.

xxv.) "Day" means calendar day.

1.2. Abbreviations:

Acronyms	Abbreviations
----------	---------------

"AAEC" means "Appreciable Adverse Effect on Competition" as per Competition Act

"BG" Bank Guarantee

"BL or B/L" Bill of Lading

"CD" Custom Duty

"CIF" Cost, Insurance and Freight Included

"MD" Managing Director

"CPSU" Central Public Sector Undertaking

"CST" Central Sales Tax

"DDO" means Direct Demanding Officer

SECTION IV – GENERAL CONDITIONS OF CONTRACT

"DGS&D" in Rate Contracts means Directorate General of Supplies and Disposals

"DP" Delivery Period

"ECS" Electronic clearing system

"ED" Excise Duty

"EMD" Earnest money deposit

"EOI" Expression of Interest (Tendering System)

"ERV" Exchange rate variations

"FAS" Free alongside shipment

"FOB" Freight on Board

"FOR" Free on Rail

"GCC" General Conditions of Contract

"GIT" General Instructions to Tenderers

"GST" Goods and Services Tax which will replace Sales Tax

"H1, H2 etc" means First Highest, Second Highest Offers etc. in Disposal Tenders means

"Incoterms" International Commercial Terms, 2010 (of ICC)

"L1, L2 etc" First or second Lowest Offer etc.

"LC" Letter of Credit

"LD or L/D" Liquidated Damages

"LSI" Large Scale Industry

"NIT" Notice Inviting Tenders.

"NSIC" National small industries corporation

"PQB" Pre-qualification bidding

"PSU" Public Sector Undertaking

"PVC" Price variation clause

"RC" Rate contract

"RR or RIR" Railway Receipt

"SBD" or "T Document" (Standard) BID / Tender Document

"SCC" Special Conditions of Contract

"SIT" Special Instructions to Tenderers

"BNPM" / Purchaser Bank Note Paper Mill India Private Limited

"SSI" Small Scale Industry

"ST" Sales Tax

"VAT" Value Added Tax

2. Application

2.1 The General Conditions of Contract incorporated in this section shall be applicable for this purchase to the extent the same are not superseded by the Special Conditions of Contract (SCC) prescribed under Section V of this document.

2.2 General Conditions of the contract shall not be changed from one tender to other.

2.3 Other Laws and Conditions that will govern the Contract:

Besides GCC and SCC following conditions and Laws will also be applicable and would be considered as part of the contract:

a) Indian Contracts Act, 1872

b) Sale of Goods Act, 1930

c) Arbitration and Conciliation Act, 1996

d) Competition Act, 2002 as amended (Amendment Act), 2007

e) Contractor's Tender Submissions including Revised Offer during Negotiations if any

f) Conditions in other parts of the Tender Documents

g) Correspondence including counter-offers if any; between the Contactor and BNPM during the Tender Finalization

h) Notification of award and Contract Documents

i) Subsequent Amendments to the Contract

j) Any other applicable law/ regulation

3. Use of contract documents and information

3.1 The supplier shall not, without BNPM's prior written consent, disclose the contract or any provision thereof including any specification, drawing, sample or any information furnished by or on behalf of BNPM in connection herewith, to any person other than the person(s) employed by the supplier in the performance of the contract emanating from this tender document. Further, any such disclosure to any such employed person shall be made in confidence and only so far as necessary for the purposes of such performance for this contract.

3.2 During the process of procurement of Security or Sensitive Machinery and Items, Tender Documents and the specifications/ drawings of such items would be issued only to Vendors having security clearance within the validity of such clearance and he shall maintain absolute secrecy and strictly control the number of copies and access to the documents and copies thereof, in addition to safeguards mentioned in sub-para above.

3.3 Further, the supplier shall not, without BNPM's prior written consent, make use of any document or information mentioned in GCC sub-clause 3.1 above except for the sole purpose of performing this contract.

3.4 Except the contract issued to the supplier, each and every other document mentioned in GCC sub-clause 3.1 above shall remain the property of BNPM and, if advised by BNPM, all copies of all such documents shall be returned to BNPM on completion of the supplier's performance and obligations under this contract.

4. Patent Rights

4.1 The supplier shall, at all times, indemnify BNPM, free of cost, against all claims which may arise in respect of goods & services to be provided by the supplier under the contract for infringement of any right protected by patent, registration of designs or trademarks. In the event of any such claim in respect of alleged breach of patent, registered designs, trademarks etc. being made against BNPM, BNPM shall notify the supplier of the same and the supplier shall, at his own expenses take care of the same for settlement without any liability to BNPM.

5. Country of Origin

5.1 All goods and services to be supplied and provided for the contract shall have the origin in India or in the countries with which the Government of India has trade relations.

SECTION IV – GENERAL CONDITIONS OF CONTRACT

5.2 The word "origin" incorporated in this clause means the place from where the goods are mined, cultivated, grown, manufactured, produced or processed or from where the services are arranged.

6. Performance Bond/ Security

6.1 Within twenty-one days after the issue of notification of award by BNPM, the supplier shall furnish performance security to BNPM for an amount equal to ten per cent of the total value of the contract, valid up to sixty days after the date of completion of all contractual obligations by the supplier, including the warranty obligations.

6.2 The Performance security shall be denominated in Indian Rupees or in the currency of the contract and shall be in one of the following forms:

a) Account Payee Demand Draft drawn on any commercial bank in India, in favour Bank Note Paper Mill India Private Limited.

b) Bank Guarantee issued by a commercial bank in India, in the prescribed form as provided in Volume I of this document.

6.3 In the event of any loss due to supplier's failure to fulfil its obligations in terms of the contract, the amount of the performance security shall be payable to BNPM to compensate BNPM for the same.

6.4 In the event of any amendment issued to the contract, the supplier shall, within twenty- one days of issue of the amendment, furnish the corresponding amendment to the Performance Security (as necessary), rendering the same valid in all respects in terms of the contract, as amended.

6.5 Subject to GCC sub-clause 6.3 above, BNPM will release the performance security without any interest to the supplier on completion of the supplier's all contractual obligations including the warranty obligations.

7. Technical Specifications and Standards

7.1 The Goods & Services to be provided by the supplier under this contract shall conform to the technical specifications and quality control parameters mentioned in Technical Specifications in Volume II and Quality Control Requirements under volume I of this tender document.

8. Packing and Marking

8.1 The packing for the goods to be provided by the supplier should be strong and durable enough to withstand, without limitation, the entire journey during transit including transshipment (if any), rough handling, open storage etc. without any damage, deterioration etc. As and if necessary, the size, weights and volumes of the packing cases shall also take into consideration, the remoteness of the final destination of the goods and availability or otherwise of transport and handling facilities at all points during transit up to final destination as per the contract.

8.2 The quality of packing, the manner of marking within & outside the packages and provision of accompanying documentation shall strictly comply with the requirements as provided in Technical Specifications and Quality Control Requirements under Volume II and in SCC under Section V. In case the packing requirements are amended due to issue of any amendment to the contract, the same shall also be taken care of by the supplier accordingly.

8.3 Packing instructions:

Unless otherwise mentioned in the Technical Specification and Quality Control Requirements and in SCC under Volume I, the

supplier shall make separate packages for each consignee (in case there is more than one consignee mentioned in the contract) and mark each package on three sides with the following with indelible paint of proper quality:

- a) Contract number and date
- b) Brief description of goods including quantity
- c) Packing list reference number
- d) Country of origin of goods
- e) Consignee's name and full address and
- f) Supplier's name and address

9. Inspection and Quality Control

9.1 BNPM and/or its nominated representative(s) will, without any extra cost to BNPM, inspect and/or test the ordered goods and the related services to confirm their conformity to the contract specifications and other quality control details incorporated in the contract. BNPM shall inform the supplier in advance, in writing, BNPM's programme for such inspection and also the identity of the officials to be deputed for this purpose.

9.2 The Technical Specification and Quality Control Requirements incorporated in the contract shall specify what inspections and tests are to be carried out and, also, where and how they are to be conducted. If such inspections and tests are conducted in the premises of the supplier or its subcontractor(s), all reasonable facilities and assistance, including access to relevant drawings, design details and production data, shall be furnished by the supplier to BNPM's inspector at no charge to BNPM.

9.3 If during such inspections and tests the contracted goods fail to conform to the required specifications and standards, BNPM's inspector may reject them and the supplier shall either replace the rejected goods or make all alterations necessary to meet the specifications and standards, as required, free of cost to BNPM and resubmit the same to BNPM's inspector for conducting the inspections and tests again.

9.4 In-case of re-inspection because of rejection of goods at first scheduled inspection due to non-conformity of goods to specifications or for any other reason attributable to the supplier, costs of the inspector(s), from second inspection onwards, towards travel & boarding shall be to vendor's account.

9.5 In case the contract stipulates pre-despatch inspection of the ordered goods at suppliers premises, the supplier shall put up the goods for such inspection to BNPM's inspector well ahead of the contractual delivery period, so that BNPM's inspector is able to complete the inspection within the contractual delivery period.

9.6 If the supplier renders the goods to BNPM's inspector for inspection at the last moment without providing reasonable time to the inspector for completing the inspection within the contractual delivery period, the inspector may carry out the inspection and complete the formality beyond the contractual delivery period at the risk and expense of the supplier. The fact that the goods have been inspected after the contractual delivery period will not have the effect of keeping the contract alive and this will be without any prejudice to the legal rights and remedies available to BNPM under the terms & conditions of the contract.

9.7 BNPM's contractual right to inspect, test and, if necessary, reject the goods after the goods' arrival at the final destination shall have no bearing of the fact that the goods have previously been inspected and cleared by BNPM's inspector during pre-despatch inspection mentioned above.

SECTION IV – GENERAL CONDITIONS OF CONTRACT

9.8 Goods accepted by BNPM and/or its inspector at initial inspection and in final inspection in terms of the contract shall in no way dilute BNPM's right to reject the same later, if found deficient in terms of the warranty clause of the contract, as incorporated under GCC Clause 16.

10. Terms of Delivery

10.1 Goods shall be delivered by the supplier in accordance with the terms of delivery specified in the contract.

11. Transportation of Goods

11.1 The supplier shall not arrange part-shipments and/ or transshipment without the express/prior written consent of BNPM.

11.2 Instructions for transportation of domestic goods including goods already imported by the supplier under its own arrangement:

In case no instruction is provided in this regard in the specification, the supplier shall arrange transportation of the ordered goods as per its own procedure.

11.3 Shipping Arrangement for Foreign Contracts: In the case of FOB/FAS contracts, shipping arrangements shall be made by the Ministry of Shipping & Transport (Chartering Wing), New Delhi, INDIA, in accordance with details given in Volume I. The Contractor shall give adequate notice to the Forwarding Agents/Nominees about the readiness of the cargo from time to time and at least six weeks' notice in advance of the required position for finalising the shipping arrangements. In the case of C&F contracts, the Contractor shall arrange shipment in accordance with the requirements of the Ministry of Shipping & Transport, New Delhi, INDIA, indicated in the Volume I (as applicable).

12. Insurance

12.1 Unless otherwise instructed in the SCC, the supplier shall make arrangements for insuring the goods against loss or damage incidental to manufacture or acquisition, transportation, storage and delivery in the following manner:

12.2 In case of supply of domestic goods on CIF destination basis, the supplier shall be responsible till the entire stores contracted for arrives in good condition at the destination. The transit risk in this respect shall be covered by the Supplier by getting the stores duly insured. The insurance cover shall be obtained by the Supplier in its own name and not in the name of BNPM or its Consignee.

12.3 In the case of FOB and C&F offers for import of Goods, insurance shall be arranged by the Purchaser. However, the supplier must give sufficient notice to the Purchaser prior to the date of shipment, so that the Insurance Cover for the shipment can be activated. The Supplier must co-ordinate so as to ensure that the Shipment sails only with Insurance cover in place.

12.4 In case of Import of Goods, even in case where the insurance is paid by the Purchaser, and loss or damage shall be made good by the Contractor free of cost, without waiting for the settlement of insurance claim. The payment after settlement of insurance claim shall be reimbursed by the Purchaser to the Contractor. Contractor shall be entirely responsible to make good loss/damage without waiting for settlement of insurance claim so that machine is commissioned within the time specified in the contract.

13. Spare parts

13.1 If specified in the List of Requirements and in the resultant contract, the supplier shall supply any or all of the following materials, Information etc. pertaining to spare parts manufactured and/or supplied by the supplier:

a) The spare parts as selected by BNPM to be purchased from the supplier, subject to the condition that such purchase of the spare parts shall not relieve the supplier of any contractual obligation including warranty obligations; and

b) In case the production of the spare parts is discontinued:

i) Sufficient advance notice shall be given to BNPM before such dis-continuation to provide adequate time to BNPM to purchase the required spare parts etc. &

ii) Immediately following such dis-continuation, the supplier shall provide BNPM designs, drawings, lay-outs & specifications of spare parts as required by BNPM free of cost.

13.2 Supplier shall carry sufficient inventories to assure ex-stock supply of consumable spares for the goods so that the same are supplied to BNPM promptly on receipt of order from BNPM.

14. Incidental services

14.1 Subject to the stipulation, if any, in the SCC under volume I and the Technical Specifications, the supplier shall be required to perform any or all of the following services.

a) Providing required jigs and tools for assembly, start-up and maintenance of the goods

b) Supplying required number of operation & maintenance manual for the goods

c) Installation and commissioning of the goods

d) Training of BNPM's operators for operating and maintaining the goods

e) Providing after sales service during the tenure of the contract

f) Providing maintenance service after expiry of the warranty period of the goods if so incorporated in the contract

14.2 Prices to be paid to the supplier by BNPM for any of the required incidental services, if not already included in the contract price during the placement of the contract, shall be settled and decided in advance by BNPM and the supplier. However, such prices shall not exceed the contemporary rates charged by the supplier to other customers for similar services.

15. Distribution of Despatch Documents for Clearance/ Receipt of Goods

15.1 The supplier shall send all the relevant despatch documents well in time to BNPM to enable BNPM to clear or receive (as the case may be) the goods in terms of the contract. Unless otherwise specified in the SCC, the usual documents involved and the practice to be followed in general for this purpose are as follows:

15.2 For Domestic Goods, including goods already imported by the supplier under its own arrangement Within 24 hours of despatch, the supplier shall notify BNPM, consignee, and others concerned if mentioned in the contract, the complete details of despatch and also supply the following documents to them by registered post/speed post (or as instructed in the contract):

a) Supplier's Invoice indicating, inter alia description and specification of the goods, quantity, unit price, total value

b) Packing list

c) Insurance certificate

d) Railway receipt/Consignment note

SECTION IV – GENERAL CONDITIONS OF CONTRACT

- e) Manufacturer's guarantee certificate and in-house inspection certificate
- f) Inspection certificate issued by BNPM's inspector, if applicable
- g) Expected date of arrival of goods at destination and
- h) Any other document(s), as and if specifically mentioned in the contract.

15.3 For Imported Goods, within 3 days of dispatch, the supplier shall notify BNPM, consignee and others concerned if mentioned in the contract, the complete details of dispatch and also supply the following documents to them by Courier (or as instructed in the Contract), besides advance intimation by Fax/ email:

- a) Clean on Board Airway Bill/Bill of Lading (B/L)
- b) Original Invoice
- c) Packing List
- d) Certificate of Origin from Seller's Chamber of Commerce
- e) Certificate of Quality and current manufacture from OEM
- f) Dangerous Cargo Certificate, if any.
- g) Insurance Policy of 110% if CIF contract.
- h) Performance Bond / Warranty Certificate

16. Warranty

16.1 The supplier warrants that the goods supplied under the contract is new, unused and incorporates all recent improvements in design and materials unless prescribed otherwise by BNPM in the contract. The supplier further warrants that the goods supplied under the contract shall have no defect arising from design, materials (except when the design adopted and / or the material used are as per BNPM's specifications) or workmanship or from any act or omission of the supplier, that may develop under normal use of the supplied goods under the conditions prevailing in India.

16.2 This warranty shall remain valid for twelve months after the goods or any portion thereof as the case may be, have been delivered to the final destination and installed and commissioned at the final destination and accepted by BNPM in terms of the contract or for fifteen months from the date of despatch of the last item to be supplied under the contract from the supplier's premises for domestic goods (including goods already imported by the supplier under its own arrangement) or for eighteen months from the date of shipment from the port of loading in the source country for imported goods offered from abroad, whichever is earlier, unless specified otherwise in the specifications.

16.3 In case of any claim arising out of this warranty, BNPM shall promptly notify the same in writing to the supplier.

16.4 Upon receipt of such notice, the supplier shall, within a reasonable span of time (or within the period, if specified in the SCC), repair or replace the defective goods or parts thereof, free of cost, at the ultimate destination. The supplier shall take over the replaced parts/goods after providing their replacements and no claim, whatsoever shall lie on BNPM for such replaced parts/goods thereafter.

16.5 In the event of any rectification of a defect or replacement of any defective goods during the warranty period, the warranty for the rectified/ replaced goods shall be extended

to a further period of twelve months from the date such rectified/ replaced goods starts functioning to the satisfaction of BNPM.

16.6 If the supplier, having been notified, fails to rectify/replace the defect(s) within a reasonable period (or within the period, if specified in the SCC), BNPM may proceed to take such remedial action(s) as deemed fit by BNPM, at the risk and expense of the supplier and without prejudice to other contractual rights and remedies, which BNPM may have against the supplier.

17. Assignment

17.1 The Supplier shall not assign, either in whole or in part, its contractual duties, responsibilities and obligations to perform the contract, except with BNPM's prior written permission.

18. Sub Contracts

18.1 The Supplier shall notify BNPM in writing of all sub contracts awarded under the contract if not already specified in its tender. Such notification, in its original tender or later, shall not relieve the Supplier from any of its liability or obligation under the terms and conditions of the contract.

18.2 Sub contract shall be only for bought out items and sub-assemblies.

18.3 Sub contracts shall also comply with the provisions of GCC Clause 5 "Country of Origin".

19. Modification of contract

19.1 Once a contract has been concluded, the terms and conditions thereof shall generally not vary. However if necessary, BNPM may, by a written order given to the supplier at any time during the currency of the contract, amend the contract by making alterations and modifications within the general scope of contract in any one or more of the following:

- a) Specifications, drawings, designs etc. where goods to be supplied under the contract are to be specially manufactured for BNPM,
- b) Mode of packing
- c) Incidental services to be provided by the supplier
- d) Mode of dispatch
- e) Place of delivery, and
- f) Any other area(s) of the contract as felt necessary by BNPM depending on the merits of the case.

19.2 In the event of any such modification/alteration causing increase or decrease in the cost of goods and services to be supplied and provided, or in the time required by the supplier to perform any obligation under the contract, an equitable adjustment shall be made in the contract price and/or contract delivery schedule, as the case may be, and the contract amended accordingly. If the Supplier doesn't agree to the adjustment made by BNPM, the supplier shall convey its views to BNPM within twenty one days from the date of the supplier's receipt of BNPM's amendment/modification of the contract.

19.3 Option Clause: By a suitable provision in the SCC, the Purchaser may reserve the right to increase the ordered quantity by 25% at any time, till final delivery date of the contract, by giving reasonable notice even though the quantity ordered initially has been supplied in full before the last date of Delivery Period.

20. Prices

SECTION IV – GENERAL CONDITIONS OF CONTRACT

20.1 Prices to be charged by the supplier for supply of goods and provision of services in terms of the contract shall not vary from the corresponding prices quoted by the supplier in its tender or during negotiations, if any, and incorporated in the contract except for any price adjustment authorized in the SCC.

21. Taxes and Duties

21.1 Supplier shall be entirely responsible for all taxes, duties, fees, levies etc. incurred until delivery of the contracted goods to BNPM.

21.2 Further instruction, if any, shall be as provided in the SCC.

22. **Terms and Mode of Payment:** Unless specified otherwise in SCC, the terms of payments would be as follows:

22.1 Unless otherwise specified in SCC, usual payment term is 100% on receipt and acceptance of goods by the Purchaser and on production of all required documents by the supplier.

22.2 For Domestic Goods: Unless otherwise specified in the SCC, payments to suppliers are usually made by account payee cheque or through ECS only.

22.2.1 Where the terms of delivery is FOR dispatching Station, the payment terms depending on the value and nature of the goods, mode of transportation etc. maybe - 60% to 90% (as specified in SIT) on proof of dispatch and other related documents and balance on receipt at site and acceptance by the consignee.

22.2.2 Where the terms of delivery is CIF destination/delivery at site/FOR destination, usual payment term is 100% on receipt and acceptance of goods by the consignee and on production of all required documents by the supplier.

22.2.3 Where goods to be supplied also need installation and commissioning by the supplier, the payment terms are generally as under:

a) For a contract with terms of delivery as F.O.R. dispatching station

i) 60% on proof of despatch along with the other specified documents.

ii) 30% on receipt of the goods at site by the consignee and balance

iii) 10% on successful installation and commissioning and acceptance by the Purchaser.

b) For a contract with terms of delivery as CIF destination/ Delivery at site/FOR destination

i) 90% on receipt and acceptance of goods by the consignee at destination and on production of all required documents by the supplier

ii) 10% on successful installation and commissioning and acceptance by the consignee.

22.3 For Imported Good: Unless otherwise specified in SCC, payments are made through an irrevocable Letter of Credit (LC).

a) Cases where Installation, Erection and Commissioning (if applicable) are not the responsibility of the Supplier- 100 % net FOB/FAS price is to be paid against invoice, shipping documents, inspection certificate (where applicable), manufacturers' test certificate, etc.

b) Cases where Installation, Erection and Commissioning are the responsibility of the Supplier-80%- 90% net FOB/FAS price (as specified in the SCC) will be paid against invoice, inspection certificate (where applicable), shipping documents etc.

and balance within 21-30 days of successful installation and commissioning at the consignee's premises and acceptance by the consignee.

c) Payment of Agency Commission against FOB/FAS Contract - Entire 100% agency commission is generally paid in Indian Rupees; after all other payments have been made to the supplier in terms of the contract.

22.4 Unless specified otherwise in the SCC, the following general conditions will apply for payment to the supplier.

22.5 The payment shall be made in the currency/ currencies authorized in the contract.

22.6 The supplier shall send its claim for payment in writing as per Section XIX - " Proforma for Bill for Payments", when contractually due, along with relevant documents etc., duly signed with date, as specified in sec and in a manner as also specified therein.

While claiming payment, the supplier is also to certify in the bill that the payment being claimed is strictly in terms of the contract and all the obligations on the part of the supplier for claiming that payment has been fulfilled as required under the contract. The supply should take place in sequence of erection and installation for claiming payment.

22.7 The important documents which the supplier is to furnish while claiming payment are:

a) Original Invoice

b) Packing List

c) Certificate of country of origin of the goods from seller's Chamber of Commerce.

d) Certificate of pre-dispatch inspection by BNPM's representative/ nominee

e) Manufacturer's test certificate

f) Performance/ Warrantee Bond

g) Certificate of Insurance

h) Bill of landing/ Airway bill/ Rail receipt or any other dispatch document, issued by a government agency (like postal department) or an agency duly authorized by the concerned ministry/department

i) Consignee's Certificate confirming receipt and acceptance of goods

j) Dangerous Cargo Certificate, if any, in case of Imported Goods.

k) Any other document specified.

22.8 While claiming reimbursement of duties, taxes etc. (like sales tax, excise duty, custom duty) from BNPM, as and if permitted under the contract, the supplier shall also certify that, in case it gets any refund out of such taxes and duties from the concerned authorities at a later date, it (the supplier) shall refund to BNPM, BNPM's share out of such refund received by the supplier. The supplier shall also refund the applicable amount to BNPM immediately on receiving the same from the concerned authorities.

22.9 In case where the supplier is not in a position to submit its bill for the balance payment for want of receipted copies of Inspection Note from the consignee and the consignee has not complained about the non-receipt, shortage, or defects in the supplies made, balance amount will be paid by the paying authority without consignee's receipt certificate after three

SECTION IV – GENERAL CONDITIONS OF CONTRACT

months from the date of the preceding part payment for the goods in question, subject to the following conditions:

- a) The supplier will make good any defect or deficiency that the consignee (s) may report within six months from the date of despatch of goods.
- b) Delay in supplies, if any, has been regularized.
- c) The contract price where it is subject to variation has been finalized.
- d) The supplier furnishes the following undertakings:

"I/ We, ----- certify that I/ We have not received back the Inspection Note duly received by the consignee or any communication from BNPM or the consignee about non-receipt, shortage or defects in the goods supplied. I/ We agree to make good any defect or deficiency that the consignee may report within three months from the date of receipt of this balance payment".

23. Delay in the supplier's performance

23.1 The time for and the date specified in the contract or as extended for the delivery of the stores shall be deemed to be the essence of the contract and the supplier shall deliver the goods and perform the services under the contract within the time schedule specified by BNPM in the List of Requirements and as incorporated in the contract.

23.2 Subject to the provision under GCC clause 28, any delay attributable to the supplier in maintaining its contractual obligations towards delivery of goods and performance of services shall render the supplier liable to any or all of the following sanctions besides any administrative action:

- a) Imposition of liquidated damages
- b) Forfeiture of its performance security and
- c) Termination of the contract for default.

23.3 If at any time during the currency of the contract, the supplier encounters conditions hindering timely delivery of the goods and performance of services, the supplier shall promptly inform BNPM in writing about the same and its likely duration and make a request to BNPM for extension of the delivery schedule accordingly. On receiving the supplier's communication, BNPM shall examine the situation as soon as possible and, at its discretion, may agree to extend the delivery schedule, with or without liquidated damages for completion of supplier's contractual obligations by issuing an amendment to the contract.

23.4 When the period of delivery is extended due to delay for reasons attributable to the supplier, the amendment letter extending the delivery period shall, inter alia contain the following conditions:

- a) BNPM shall recover from the supplier, under the provisions of the clause 24 of the General Conditions of Contract, liquidated damages on the goods and services, which the Supplier has failed to deliver within the delivery period stipulated in the contract.
- b) That no increase in price on account of any ground whatsoever, including any stipulation in the contract for increase in price on any other ground and, also including statutory increase in or fresh imposition of customs duty, excise duty, sales tax or on account of any other tax or duty which may be levied in respect of the goods and services specified in the contract, which takes place after the date of delivery stipulated in the contract shall be admissible on the said goods and services delivered and performed after the date of the delivery stipulated in the contract.

c) But nevertheless, BNPM shall be entitled to the benefit of any decrease in price on account of reduction in or remission of customs duty, excise duty, sales tax or any other duty or tax or levy or on account of any other grounds, which takes place after the expiry of the date of delivery stipulated in the contract.

23.5 The supplier shall not despatch the goods after expiry of the delivery period. The supplier is required to apply to BNPM for extension of delivery period and obtain the same before despatch. In case the supplier despatches the goods without obtaining an extension, it would be doing so at its own risk and no claim for payment for such supply and/or any other expense related to such supply shall lie against BNPM.

24. Liquidated damages

24.1 Subject to GCC clause 28, if the supplier fails to deliver any or all of the goods or fails to perform the services within the time frame(s) incorporated in the contract, BNPM shall, without prejudice to other rights and remedies available to BNPM under the contract, deduct from the contract price, as liquidated damages, a sum equivalent to the 0.5% (Half) percent (or any other percentage if prescribed in the SCC) of the delivered price of the delayed goods and/ or services for each week of delay or part thereof until actual delivery or performance, subject to a maximum deduction of the 10% (or any other percentage if prescribed in the SCC) of the delayed goods' or services' contract price(s). During the above mentioned delayed period of supply and/ or performance, the conditions incorporated under GCC sub-clause 23.4 above shall also apply.

24.2 Liquidated Damage for not meeting performance guarantee shall be assessed and recovered from the Supplier, if applicable. The quantum of Liquidated damages shall be as specified in SCC.

24.3 If the equipment/system while testing, in accordance with the performance requirement of the Contract, fails to meet those performance parameters, the damages suffered by the purchaser may not be quantified in terms of money with any reasonable certainty. Therefore any Liquidated damage set forth in the Contract shall represent a reasonable determination of the amount of damage that the Purchaser will suffer, and shall not be considered as penalties. The Supplier thereby waives any defence to Purchaser's recovery of such Liquidated Damages on the plea that actual damages are ascertainable or that such Liquidated damages do not represent a reasonable determination of damages suffered by Purchaser or are penalties.

24.4 If the LD exceeds the specified limit, the Purchaser shall reserve the right to cancel/terminate the Contract as per clause 26 of GCC.

25. Custody and Return of BNPM Materials/ Equipment Documents loaned to Contractor

25.1 Whenever stores are required to be issued to the firm/contractor for fabrication or prototypes or sub-assemblies are issued for guidance in fabrication, these would be issued against appropriate Bank Guarantee as specified in SCC. In addition to the Bank Guarantee, appropriate insurance may be asked for if specified in the SCC.

25.2 In-case of failure of returning of all drawings and samples issued to the contractor in connection with the contract, besides withholding final payment, any other sanction, as deemed fit by BNPM, shall be issued against the supplier.

26. Termination for default

26.1 BNPM, without prejudice to any other contractual rights and remedies available to it (BNPM), may by written notice of default sent to the supplier, terminate the contract in whole or in part, if the supplier fails to deliver any or all of the goods or fails

SECTION IV – GENERAL CONDITIONS OF CONTRACT

to perform any other contractual obligation(s) within the time period specified in the contract, or within any extension thereof granted by BNPM pursuant to GCC sub-clauses 23.3 and 23.4.

26.2 In the event of BNPM terminates the contract in whole or in part, pursuant to GCC sub-clause 26.1 above, BNPM may procure goods and/ or services similar to those cancelled, with such terms and conditions and in such manner as it deems fit at the "Risk and Cost" of the supplier and the supplier shall be liable to BNPM for the extra expenditure, if any, incurred by BNPM for arranging such procurement.

26.3 Unless otherwise instructed by BNPM, the supplier shall continue to perform the contract to the extent not terminated.

27. Termination for insolvency

If the supplier becomes bankrupt or otherwise insolvent, BNPM reserves the right to terminate the contract at any time, by serving written notice to the supplier without any compensation, whatsoever, to the supplier, subject to further condition that such termination will not prejudice or affect the rights and remedies which have accrued and I or will accrue thereafter to BNPM.

28. Force Majeure

28.1 In the event of any unforeseen event directly interfering with the supply of stores arising during the currency of the contract, such as war, hostilities, acts of the public enemy, civil commotion, sabotage, fires, floods, explosions, epidemics, quarantine restrictions, strikes, lockouts, or acts of God, the Contractor shall, within a week from the commencement thereof, notify the same in writing to the Purchaser with reasonable evidence thereof. Unless otherwise directed by BNPM in writing, the supplier shall continue to perform its obligations under the contract as far as reasonably practical, and shall seek all reasonable alternative means for performance not prevented by the Force Majeure event. If the force majeure condition(s) mentioned above be in force for a period of 90 days or more at any time, either party shall have the option to terminate the contract on expiry of 90 days of commencement of such force majeure by giving 14 days' notice to the other party in writing. In case of such termination, no damages shall be claimed by either party against the other, save and except those which had occurred under any other clause of this contract prior to such termination.

28.2 Notwithstanding the provisions contained in GCC clauses 23, 24 and 26, the supplier shall not be liable for imposition of any such sanction so long the delay and/ or failure of the supplier in fulfilling its obligations under the contract is the result of an event of Force Majeure.

28.3 In case due to a Force Majeure event BNPM is unable to fulfil its contractual commitment and responsibility, BNPM will notify the supplier accordingly and subsequent actions taken on similar lines described in above sub-paragraphs.

29. Termination for convenience

29.1 BNPM reserves the right to terminate the contract, in whole or in part for its (BNPM's) convenience, by serving written notice on the supplier at any time during the currency of the contract. The notice shall specify that the termination is for the convenience of BNPM. The notice shall also indicate inter-alia, the extent to which the supplier's performance under the contract is terminated, and the date with effect from which such termination will become effective.

29.2 The goods and services which are complete and ready in terms of the contract for delivery and performance within thirty days after the supplier's receipt of the notice of termination shall be accepted by BNPM following the contract

terms, conditions and prices. For the remaining goods and services. BNPM may decide:

a) To get any portion of the balance completed and delivered at the contract terms, conditions and prices; and / or

b) To cancel the remaining portion of the goods and services and compensate the supplier by paying an agreed amount for the cost incurred by the supplier towards the remaining portion of the goods and services.

30. Governing language

30.1 The contract shall be written in English language following the provision as contained in GIT clause 2. All correspondence and other documents pertaining to the contract, which the parties exchange, shall also be written accordingly in that language.

31. Notices

31.1 Notice, if any, relating to the contract given by one party to the other, shall be sent in writing or by cable or telex or facsimile and confirmed in writing. The procedure will also provide the sender of the notice, the proof of receipt of the notice by the receiver. The addresses of the parties for exchanging such notices will be the addresses as incorporated in the contract.

31.2 The effective date of a notice shall be either the date when delivered to the recipient or the effective date specifically mentioned in the notice, whichever is later.

32. Code of Ethics

BNPM as well as Bidders, Suppliers, Contractors, and Consultants under BNPM contracts shall observe the highest standard of ethics during the procurement or execution of such contracts. In pursuit of this policy, for the purposes of this provision, the terms set forth below are defined as follows:

a) "Corrupt practice" means the offering, giving, receiving, or soliciting, directly or indirectly, of anything of value to influence the action of a public official in the procurement process or in contract execution;

b) "Fraudulent practice" means a misrepresentation or omission of facts in order to influence a procurement process or the execution of a contract;

c) "Collusive practice" means a scheme or arrangement between two or more Bidders, with or without the knowledge of the Purchaser, designed to establish bid prices at artificial, non-competitive levels; and

d) "Coercive practice" means harming or threatening to harm, directly or indirectly, persons or their property, procurement process or affect the execution of a contract.

e) A particular violation of ethics may span more than one of above mentioned unethical practices.

32.1 The following policies will be adopted in order to maintain the standards of ethics during procurement:

a) A proposal for award will be rejected if it is determined that the Bidder recommended for award has, directly or through an agent, engaged in corrupt, fraudulent, collusive or coercive practices in competing for the Contract in question.

b) A contract will be cancelled if it is determined at any time that BNPM representatives/officials have directly or indirectly, engaged in corrupt, fraudulent collusive or coercive practices during the procurement or the execution of that contract.

SECTION IV – GENERAL CONDITIONS OF CONTRACT

c) In case any individual staff is found responsible, suitable disciplinary proceedings should be initiated against such staff under the applicable conduct rules. The existing provisions under the Indian law including the instructions of Central Vigilance Commission should be followed in this regard.

d) Firms or individuals shall be banned/ blacklisted after following due process, including declaring them ineligible, either indefinitely or for a stated period of time, to be awarded a BNPM contract, if it at any time determines that they have, directly or through an agent, engaged in corrupt, fraudulent, collusive or coercive practices in competing for, or in executing, a BNPM contract.

33. Resolution of disputes

33.1 If dispute or difference of any kind shall arise between BNPM and the supplier in connection with or relating to the contract, the parties shall make every effort to resolve the same amicably by mutual consultations. If the parties fail to resolve their dispute or difference by such mutual consultation within twenty one days of its occurrence, then, unless otherwise provided in the SCC, either BNPM or the supplier may seek recourse to settlement of disputes through arbitration as per The Arbitration and conciliation Act 1996 as per following clause.

33.2 Arbitration Clause: - Any dispute or difference whatsoever arising between the Parties out of or relating to the construction, meaning, scope operation or effect of this Agreement or the validity or the breach thereof shall be settled by arbitration in accordance with the Arbitration and Conciliation Act, 1996 and under the Rules of Arbitration of the Indian Council of Arbitration and the award made in pursuance thereof shall be binding on the Parties. The Arbitral Tribunal shall consist of three Arbitrators. The venue of the Arbitration shall be Bangalore and it shall be conducted in English language.

34. Applicable Law

34.1 The contract shall be interpreted in accordance with the laws of India.

34.2 Irrespective of the place of delivery, or the place of performance or the place of Payments under the contract, the contract shall be deemed to have been made at the place from which the notification of acceptance of the tender has been issued.

34.3 The courts of the place from where the notification of acceptance has been issued- shall alone have jurisdiction to decide any dispute arising out or in respect of the contract.

35. Secrecy

35.1 The Contractor shall take all reasonable steps necessary to ensure that all persons employed in any work in connection with the contract, have full knowledge of the Official Secrets Act and any regulations framed thereunder.

35.2 Any information obtained in the course of the execution of the contract by the Contractor,; his servants or agents or any person so employed, as to any matter whatsoever, which would or might be directly or indirectly, of use to any enemy of India, must be treated secret and shall not at any time be communicated to any person.

35.3 Any breach of the aforesaid conditions shall entitle the Purchaser to cancel the contract and to purchase or authorise the purchase of the stores at the risk and cost of the Contractor, In the event of such cancellation, the stores or parts manufactured in the execution of the contract shall be taken by the Purchaser at such price as he considers fair and reasonable and the decision of the Purchaser as to such price shall be final and binding on the Contractor.

Part II: Additional General Conditions of Contract for specific Types of Tenders in addition/ modification to clauses mentioned above:

36. Disposal / Sale of Scrap by Tender

36.1 During the currency of contract, no variation in price or rate shall be admissible.

Integrity Pact

36.2 Payment and Default

36.2.1 Payment may be made in the form of cash or Demand Draft /Pay order issued by any scheduled commercial bank and drawn in favour of the Account mentioned in the NIT.

36.2.2 No interest will be paid to the purchaser for the amounts paid or deposited with the BNPM and subsequently found refundable to the purchaser under any of the conditions of the contract.

36.2.3 If the purchaser fails to deposit sale value for a sold lot within the allowed period as per relevant clause BNPMIPL may forfeit the security deposit. Requests for an extension of this period, made by the purchaser may be considered by the BNPMIPL and may at its discretion, on the merits of the case, allow further time not excluding 50 days from the date of the contract. Interest shall be leviable on such amount at a rate 2% per annum higher than the PLR of State Bank of India, from the date of expiry of the payment date to actual date of payment (actual date of payment inclusive).

36.2.4 The lot or lots in respect of which forfeiture has been made, shall be deemed to have been abandoned by the purchaser to all intents and purposes and may be re-sold or otherwise disposed of at the discretion of the BNPMIPL without reference to the purchaser concerned and without incurring any liability on part of BNPMIPL whatsoever in respect there under.

36.2.5 In case extension is granted by BNPMIPL and due to late payment of sale amount the delivery cannot be completed by the purchaser, in accordance with the relevant clause of Special Conditions of Tender sale, then ground rent shall also be leviable as per relevant clause of Special Conditions of Tender sale.

36.2.6 On production of proof of having made payment, nominated authority shall issue a delivery order authorizing the purchaser to take delivery of the Scrap Materials.

36.3 Deliveries, Delays and Breach of Contact

36.3.1 The Title of goods or material sold shall not be deemed to have been passed to the Purchaser / Bidder until and unless the full and final payment has been made by the purchaser, in accordance with the contract to the BNPMIPL and the authorized Officer has issued the Delivery Order in favour of the purchaser. The materials sold may be removed from the premises only on production of the cash receipt for the payment and a delivery order from the Officer authorized by the BNPMIPL.

36.3.2 Unless specified otherwise in SIT, delivery period for lifting of material shall be within 60 days from the date of finalization of contract agreement.

36.3.3 The work of delivery will be supervised by Stock Holder or his authorized representative, representative of accounts Department and Security Staff duly authorized by BNPMIPL for the propose of delivery. Delivery will be allowed during working hours.

36.3.4 No delivery of or materials sold shall be given on Sundays, Gazetted holidays and other shall holidays observed by BNPMIPL. The delivery of the goods or material shall be effected from the premises concerned only during its normal working hours. In

SECTION IV – GENERAL CONDITIONS OF CONTRACT

order to complete the delivery within the working hours all loading must cease half an hour before the normal closing time of the concerned premises. The decision of the BNPMIPL with regard to the working hour shall be final and binding on the purchaser. Purchaser will not be allowed to lift the Scrap Material from more than one location at a time.

36.3.5 The purchased stores will be carried away by the purchaser at his risk and no claims against the BNPMIPL will be entertained for shortage in weight which may be discovered after the materials have left the premises wherefrom delivery is taken. If required the purchaser shall provide his own bags, cases or other receptacles for the removal of the scrap.

36.3.6 The BNPMIPL shall not be responsible for any accident that may occur to purchaser's labours /servants for any reasons whatsoever. The purchaser will himself have to ensure the safety of his workers and shall be liable to pay claims, whatsoever if any. BNPMIPL will not carry any responsibility of such payments. The purchaser will be responsible to supply personal protection Equipments to his labour/servant and staff and no additional charges are admissible for the same.

36.3.7 The materials sold, shall be removed by the purchaser within the period specified in relevant clause of Special Condition of Sale.

36.3.8 If due to any default on the part of the BNPMIPL, the purchaser is unable to remove the materials sold within the specified period, the BNPMIPL may extend the period therefore and in such an event purchaser will be entitled to take delivery of the goods or the materials sold within such extended Delivery period.

36.3.9 If contractor fails to lift sold scrap within the specified period, penalty shall be levied at the rate of 0.5% per day of the value of un-removed Scrap. Moreover the material shall remain at the purchaser's risk until removal thereof. Further BNPMIPL will be entitled to charge the ground rent as stated in relevant Para of SCC, for the area in which the materials sold are kept or stored — which would be recovered by the BNPMIPL from the Purchaser before removal of the material and In the event of default in payment thereof, the BNPMIPL at may its discretion shall be entitled to order the re-sale of such materials and forfeit the Security deposit or sale amount or both, paid by the purchaser.

36.3.10 If the purchaser makes slow progress with his contract and the BNPMIPL is of opinion that he may fail to fulfill the contract within the time specified in the conditions of sale, it will be lawful for the BNPMIPL to cancel the whole contract or such portion thereof as may not have been completed and the BNPMIPL shall be at liberty to dispose off the goods in any manner at the risk and expense of the purchaser.

36.3.11 The purchaser will have to comply with the provisions of the Contract Labour (Regulations and Abolition Act 1970 and Central Rules 1971 and obtain license from the Assistant Labour Commissioner or the competent authorities empowered to issue such license. Any failure on the part of the purchaser in this regard will be at his risk and consequences. He shall comply with Workman's Compensation Act 1923, Payment of Wages Act 1936, and Minimum Wages Act 1948 and all the other related statutory and legal provisions and obligations, The purchaser shall also indemnify the BNPMIPL against any claim / liabilities that may occur to the contractor's labours and servants due to any reasons whatsoever.

36.3.12 If the purchaser makes default in complying with any of the condition of the contract, the sale of lot or lots in respect of which such default is made may be cancelled and such lot or lots may be put up again for sale and in such an event if a lower price is offered and accepted for such lot or lots then the purchaser shall be liable to pay the difference

in price thereof together with all expenses occasioned by such resale in default to the BNPMIPL provided further that the purchaser in default shall not be entitled to claim any profit which may arise from such resale.

37. Integrity Pact

37.1 If the tender value is above 10 crore, the Contractor shall sign the Integrity Pact as per the prescribed format (Section XX).

SECTION V – SPECIAL CONDITIONS OF CONTRACT

The following Special Conditions of Contract (SCC) will apply for this purchase. The corresponding clauses of General Conditions of Contract (GCC) relating to the SCC stipulations have also been incorporated below. These Special Conditions will modify/substitute/supplement the corresponding (GCC) clauses.

Whenever there is any conflict between the provision in the GCC and that in the SCC, the provision contained in the SCC shall prevail.

(Clauses of GCC listed below include a possibility for variation in their provisions through SCC. There could be other clauses in SCC as deemed fit)

Sl. No.	GCC Clause No.	Topic	SCC Provision
1	1 to 5	Definitions; Interpretation and Abbreviations, Application, Use of contract documents and information, Patent Rights, Country of Origin	No Change
2	6	Performance Security	Successful bidder shall submit bank guarantee for 10% of contract value valid up to Sixty days after the date of completion of all contractual obligations, including warranty period (if any). (Please refer GCC Clause 6 under Section IV).
3	7 to 15	Technical Specifications and Standards, Packing and Marking, Inspection and Quality Control, Terms of Delivery, Transportation of Goods, Insurance, Spare parts, Incidental Services, Distribution of Dispatch Documents for Clearance/ Receipt of Goods	No Change.
4	16	Warranty	Not Applicable
5	17 & 18	Assignment, Sub Contracts	No Change
6	19	Modification of contract	No Change.
7	20 & 21	Prices, Taxes and Duties	GST as applicable shall be quoted. Also, refer point 13.
8	22	Terms and Mode of Payment	100% amount of the invoiced value shall be released after receipt of goods by the consignee at destination and on production of all required documents by the supplier.

SECTION V – SPECIAL CONDITIONS OF CONTRACT

9	23 to 32	Delay in the supplier's performance, Liquidated damages, Custody and Return of BNPM's Materials/ Equipment/ Documents loaned to Contractor, Termination for default, Termination for insolvency, Force Majeure, Termination for convenience, Governing language, Notices, Code of Ethics	No Change
10	33	Resolution of disputes	Arbitration proceedings will be held at Mysuru and venue of arbitration will be Mysuru.
11	34-35	Applicable Law, Secrecy	No Change
12	36-37	Integrity Pact, Disposal / Sale of Scrap by Tender	Not applicable to this tender

SPECIFIC TERMS AND CONDITIONS OF CONTRACT:

13. Clause related to payment of CGST, SGST, UTGST & IGST:

The suppliers are required to adhere the following procedure in order to honour the payment against CGST, SGST, IGST & UTGST in the invoice:

- i. An invoice issued by the supplier of goods or services or both should be in accordance with the provisions of section 31 of the CGST Act and should contain all the prescribed information's in accordance with Chapter VI of CGST Rules 2017;
- ii. A debit note issued if any, by a supplier should be in accordance with the provisions of section 34 of the CGST Act;
- iii. The supplier should mandatorily upload the aforementioned documents in GSTR-1, details of outward supplies of goods or services within the prescribed time under GST Act;
- iv. The supplier should provide the relevant documents to confirm the tax charged on the invoice has been paid to the credit of government after adjusting with ITC if any.

Notwithstanding above, the supplier should provide indemnification as follows: "In the event of non-compliances with respect to GST Act and Rules by the supplier, the purchaser is allowed to adjust the GST amount from retention amount (either in BG or in Cash) held by the company. If no amount is available for recovery, the supplier will refund the GST liability within 10 days from the date of GST reversal in GSTRN"

The above requirements are mandatory to claim any GST liability, failing which, the GST liability will not be paid/reimbursed/accepted.

14. **Site Inspection:** Bidders may visit the site at their own cost and they may obtain all necessary information as to risks, contingencies and other circumstances which may influence or alter their tender before submitting their offer. The bidders shall be deemed to have full knowledge of the work involved, whether they inspect it or not and no extra charges consequent on any misunderstanding or otherwise shall be allowed.
15. **Rejection Replacement:** In case of supplies, materials not meeting our specification will be rejected outright and the rejected material shall be taken back within 14 days at the cost and risk of the supplier and replacement should be made within 15 days from the date of intimation. No payment shall be made for rejected item. If the material is not taken back within the stipulate period, BNPM reserves the right to dispose off the material at the risk and expense of the vendor as per provision under Section IV: General conditions of contract.

SECTION V – SPECIAL CONDITIONS OF CONTRACT

16. Risk Purchase Clause: If the supplier fails to abide by the terms and conditions of this agreement, or fails to supply the material/service as per the delivery schedule or any time repudiates the contract, the purchaser will have the right to

- a) Appropriate the Security Deposit (by invoking the Performance bank guarantee) deposited by the supplier as per clause 6.0 of GCC and procure the tender item/render service from other agencies at the risk and cost of the supplier.
- b) The cost difference between the alternative arrangement and existing contract value wherein default has been made will be recovered from the supplier along with the other incidental charges.

In case of procurement through alternative sources, if procurement price is lower than the existing contract value wherein default has been made, in such case no benefit on this account will be passed on to the supplier.

17. Fore-Closure Clause:

If at any time during the continuation of this contract, the use of material ordered in this contract is completely banned or due to drastic change in Government policy its use as, raw material is discontinued or is declared hazardous to public health or cause rising to civil commotion, epidemics, wide-spread strikes and 21 days' notice of such eventualities is given by purchaser to the seller, the seller without any right to enforce the contract, will agree to the fore-close the performance of balance portion of this contract and in that event no claim for damages or loss will be lodged against the purchaser.

18. Security and Confidentiality: BNPMIPL is a security organization and the premise is declared as 'Prohibited Area' by the Govt. of Karnataka. Hence the supplier has to abide by the security rules of the Company.

(To be signed & stamped and submitted along with Techno-commercial Bid Part -I)

SECTION VI – LIST OF REQUIREMENTS

Sch. No.	Brief Description of Goods	Tentative Quantity (with unit)	**Earnest Money Deposit (in Rs.)	Remarks
1	Collapsible Packing Box (740x820x970)mm, Marking-D	24,000 Sets	Not applicable	Refer Section – VI for List of requirements
2	Collapsible Packing Boxes (740*800*970)MM, Marking CC	4,500 Sets		
3	Collapsible Packing Box-740x780x970 MM, Marking-C	9,000 Sets		
4	Collapsible Packing Box (740x740x970)mm, Marking-HD/L	3,000 Sets		
5	Collapsible Packing Boxes (710 x 840 x 970) mm Marking -XX	7,500 Sets		

1. PERIOD OF CONTRACT

The rate contract shall be entered with the successful bidder initially for a period of (01) one year and later extendable for further six months at the same rates, terms & conditions of the tender. The rate contract shall be extended by BNPMIPL based on the satisfactory performance of the contractor. However, the contract can be terminated at any point of time at the discretion of BNPMIPL. Also bidders, may refer forfeiture of Security Deposit clause (GCC Clause 6 under Section IV) for any breach of contract.

2. Tender quantity:

Quantities mentioned above are illustrative / indicative and not exhaustive; the actual requirement may vary (increase / decrease) as per production plan within the contract period. The total contract value shall be computed on the basis of individual quantity for calculations of Performances Bank Guarantee to be furnished by the successful bidder/(s).

3. It is the responsibility of the supplier to arrange for transportation and supply the material on DAP-BNPM MYSURU basis. BNPMIPL requires material on DAP site office, Note Mudran Nagar, Mysore basis only. The quoted price should be inclusive of Transit Insurance.

Place of Delivery:

Engineering Stores
Bank Note Paper Mill India Private Limited
Paper Mill Compound
Note Mudran Nagar,
Mysuru - 570 003

(To be signed & stamped and submitted along with Techno-commercial Bid Part -I).

SECTION VII – TECHNICAL SPECIFICATIONS

Collapsible plywood packing box side cover design

/03/17

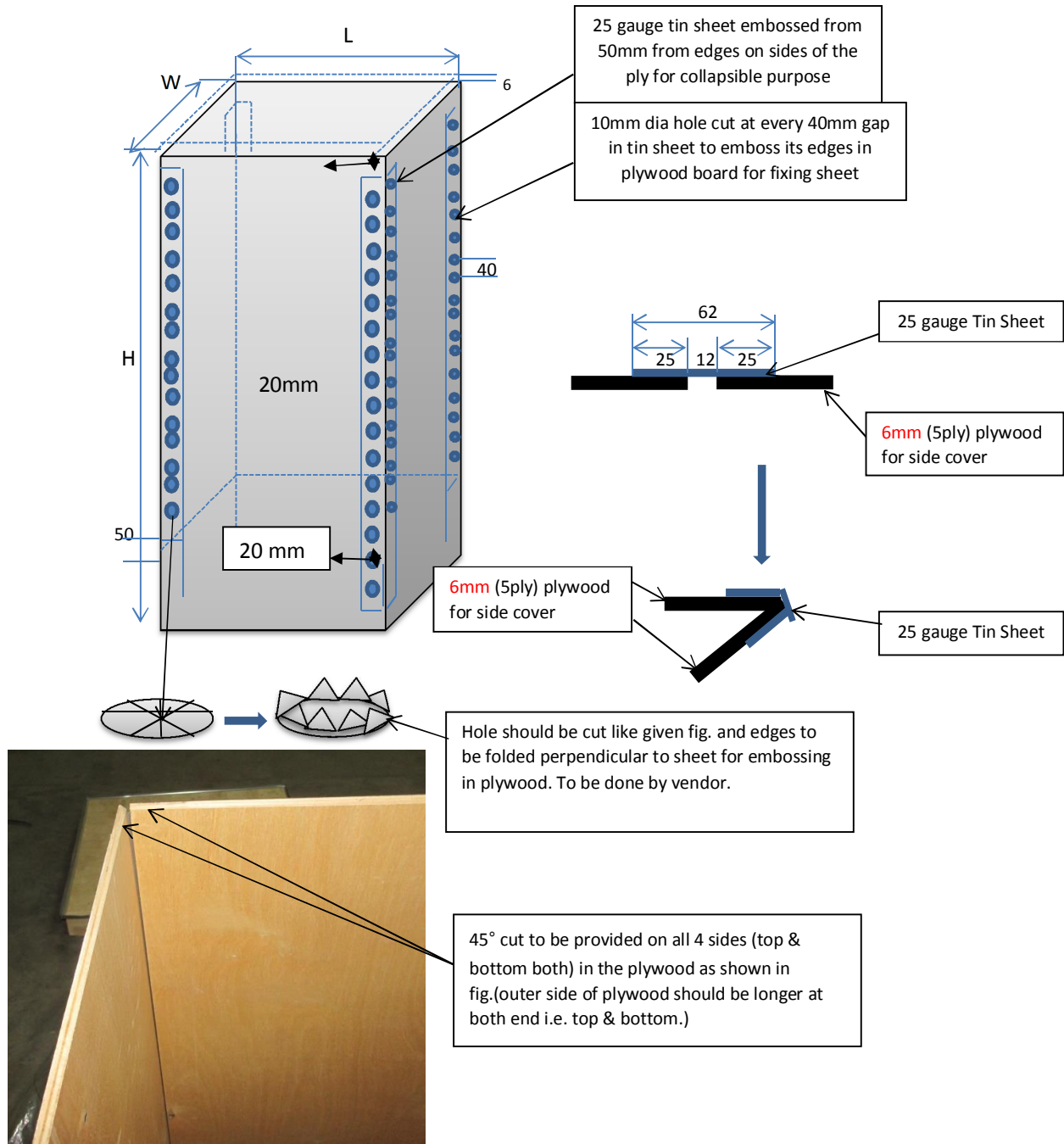

SECTION VII - TECHNICAL SPECIFICATIONS

Top cover design

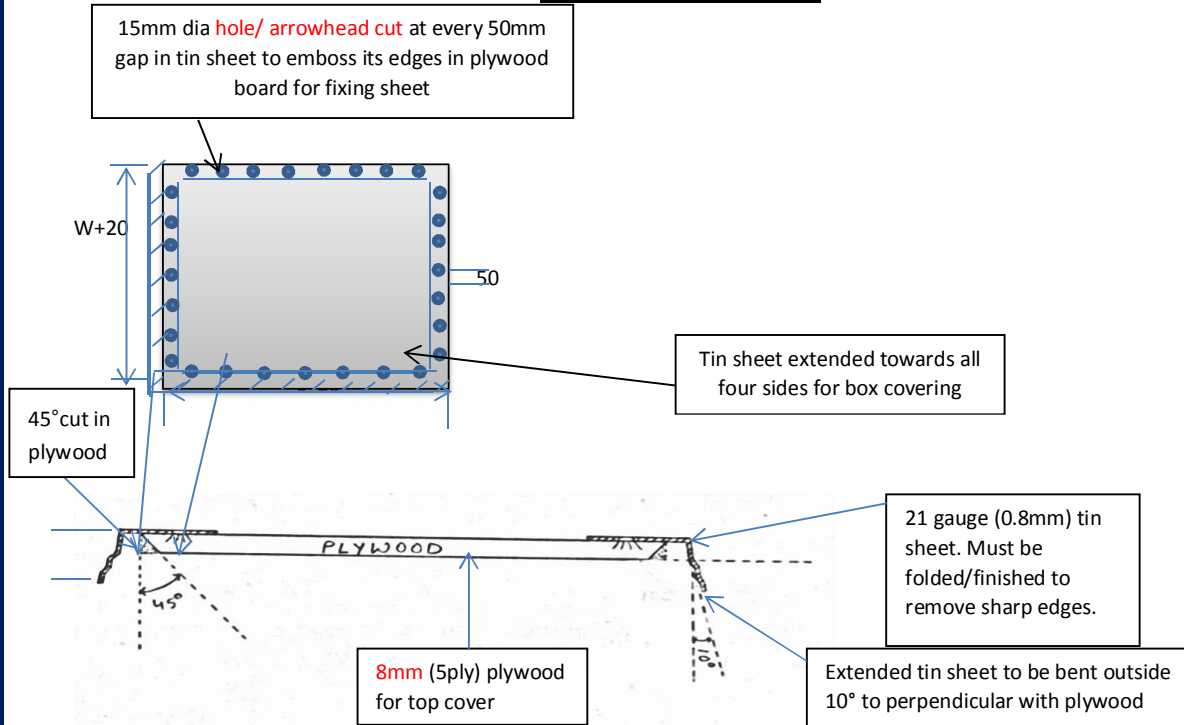

Indicative view for tin sheet fixing

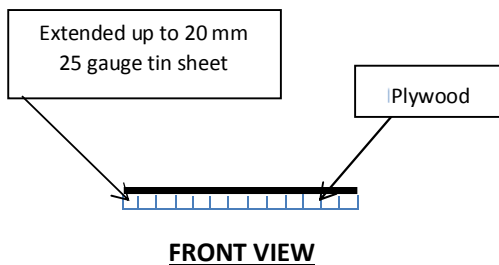

SECTION VII - TECHNICAL SPECIFICATIONS

Pallet

21 gauge (0.8mm) tin sheet, with height at least 5 +/-1mm higher than the top surface of the plywood. Must be folded/finished to remove sharp edges.

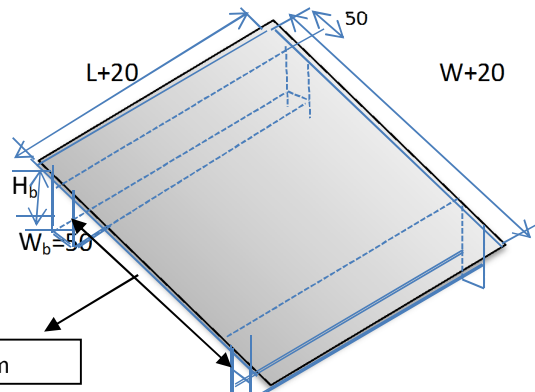

555 (+5/-0)mm

Figure without tin sheet

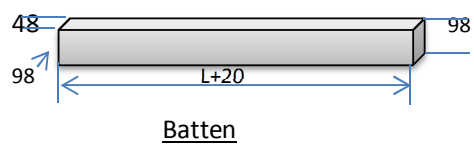

Batten

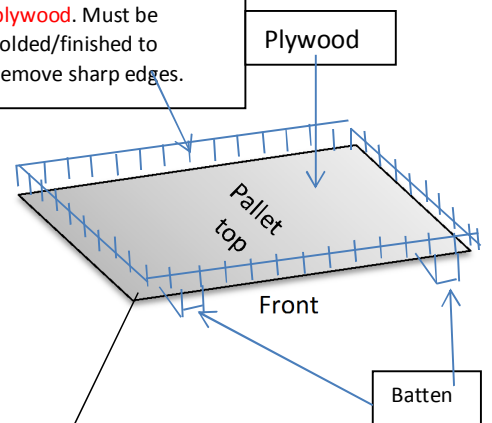

Plywood

Batten

45° cut in plywood (all 4 sides)

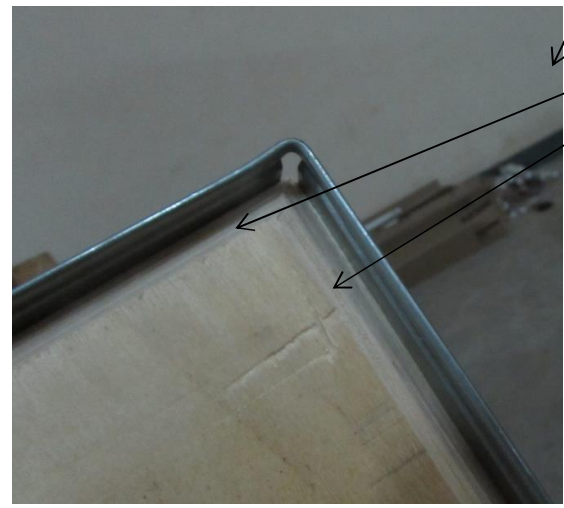

SECTION VIII – QUALITY CONTROL REQUIREMENTS

Inside dimensions of collapsible wooden box for packing of bank note paper sheets			
Marking	Length (mm) (L)	Width (mm) (W)	Height (mm) (H)
XX	820	690	970
C	760	720	970
CC	780	720	970
D	800	720	970
L/DH	720	720	970

OVERALL TOLERANCE OF PLYWOOD BOXES ALONG WITH BASE PALLET: The following tolerances on the nominal sizes:-

Dimension	Tolerance
Length	+/- 5 mm
Width	+/- 5 mm
Thickness	+/- 0.3 mm

The firm should maintain the tolerance of pallet, lid and packing box on the same side, ie, either all positive or all negative.

SPECIFICATION FOR PLY WOOD BOXES

1. 6mm (5ply) thick plywood board to be used for side cover. It should be collapsible.
2. 8mm (5ply) thick plywood board to be used for top cover.
3. 15mm (9ply) thick plywood board to be used for bottom base.
4. Two no of bottom batten to be fitted across the width for pallet making.
5. Bottom battens to be fitted inside from the edges while ensuring distance between two inside edge of battens should not be less 555mm. Distance to edge of pallet from outside edge of batten to be maintained uniform.
6. Batten size-98 mm (height) X48 mm (width) X (L+20) mm long for pallet. Tolerance in runners is +/-2mm.
7. 10 SWG, 75mm long 5/6 ring/screw shank nails in a row to be used to join bottom batten. The nail heads should not protrude out on pallet surface.
8. All ply should be class "A" and as per IS: 303 and top brands available in market i.e.
 - a. Kitply
 - b. Century Ply
 - c. Green Ply
 - d. National Plywood
 - e. Sarda Plywood
 - f. or equivalent.
9. All plywood and battens should be fine finished and free from knots, cracks and other wood defects.
10. Edges of the extended tin sheet should be folded in top cover and bottom pallet. The end of tin sheet should overlap the starting edge by a minimum of 10mm.
11. Nailing of tin sheet should be avoided and Pallets/ Top lids/ Side covers containing embossed tin sheets only will be accepted.

SECTION VIII – QUALITY CONTROL REQUIREMENTS



COMPLETE SET OF COLLAPSIBLE WOODEN PACKING BOX(indicative fig)





COLLAPSED CONDITION OF SIDE COVER (indicative fig)

SECTION VIII – QUALITY CONTROL REQUIREMENTS

PLYWOOD BOXES TO BE MARKED WITH FOLLOWING SYMBOLS:-

Each Plywood boxes should to be marked following

- Month & Year of Manufacturing
- Arrow marking for opening. 
- The material should not be stored outside. 
- Recycling Symbol. 
- Company Logo & Name (Bank Note Paper Mill India Private limited, Mysuru) in the top left along the width of the side cover. (To be provided to successful bidder)
- A rectangular box with bold border to be provided on the top right (90mm from top edge, 150mm from the right edge) along the width of the side cover as shown in the drawing (Refer Drawing: Location of Logo).
- Manufacturer Company identifier to be provided on boxes.
- Bottom/Top Cover/Siding to be marked with alphabet as per denomination in uppercase and **bold** (thickness-15mm) with height-100mm and width-80mm of alphabet.

The edge at which side cover is to be bend should be marked with ">" to understand in which direction box shall be opened or collapsed.

SECTION VIII – QUALITY CONTROL REQUIREMENTS

PACKING & TRANSPORTATION INSTRUCTION:

Plywood boxes to be transported in covered vehicles.

1. Wooden Pallet Packing Instruction :

- i. Stack – 25 numbers (maximum) with surface to surface stacking. A suitable wooden bit/piece of desired thickness may be placed between the surface of the pallets to maintain gap and avoid touching of metal strip.
- ii. Strapped and Denomination labelling.



2. Side Cover packing instruction :

- i. In collapsible condition Stack – 75 numbers (Maximum) packed within wooden cage with leg height of min 100 mm for handling by pallet truck, edge protection.
- ii. Four sided strapping, stretch wrapped, denomination labelling.



SECTION VIII – QUALITY CONTROL REQUIREMENTS

3. Top Lid packing instruction :

- i. Stack – 50 Nos (maximum) over wooden pallet.
- ii. Strapped, Stretch Wrapped.
- iii. Gap between 2 top lids kept upside down, Denomination labelling. A suitable wooden bit/piece of desired thickness may be placed between the lower and upper surface of the top lids to maintain gap and avoid touching of metal strip.



Guidelines for LOGO

- 1) The LOGO should be coloured. The colour specification is as follows:
Pantone 349 U
C 90 M 30 Y 95 K 30
- 2) The Logo dimensions:
The ratio of actual to design shown below should be 2:1

SECTION VIII – QUALITY CONTROL REQUIREMENTS

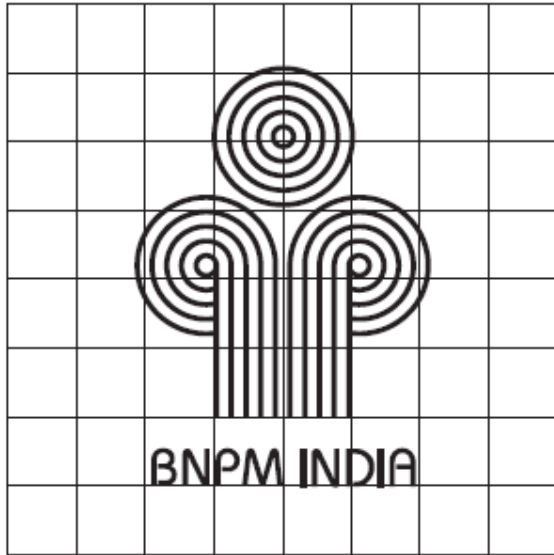

h 51.7 x w 36.4 mm

- Note: (1) Always use the artwork file provided in a CD for logo.
(2) Always re-size the logo proportionately.
(3) Do not use logo smaller than 17.5 mm in height.*

3) Safe Zone/White Space:

The x- width space from all the four sides of the logo depends upon the type of configuration through which logo ensures visibility. For example, note the horizontal configuration x-width space as shown in the below illustration. Never compose or write anything within the safe zone.

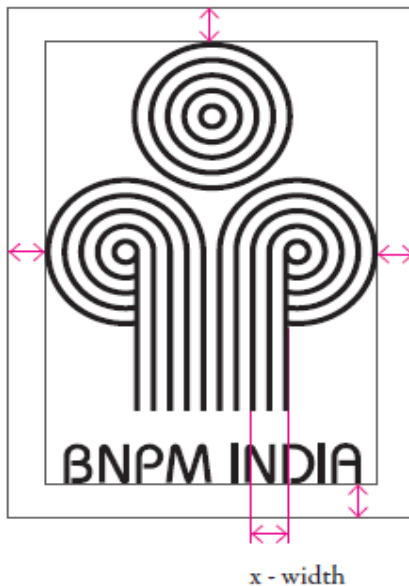

4) The fonts used in the LOGO:

SECTION VIII – QUALITY CONTROL REQUIREMENTS

Fonts: Bauhaus-Thin, Regular

ABCDEFGHIJKLMNOPQRSTUVWXYZ

abcdefghijklmnopqrstuvwxyz

1234567890

BNPM INDIA

5) Location for BNPM logo & consignee label

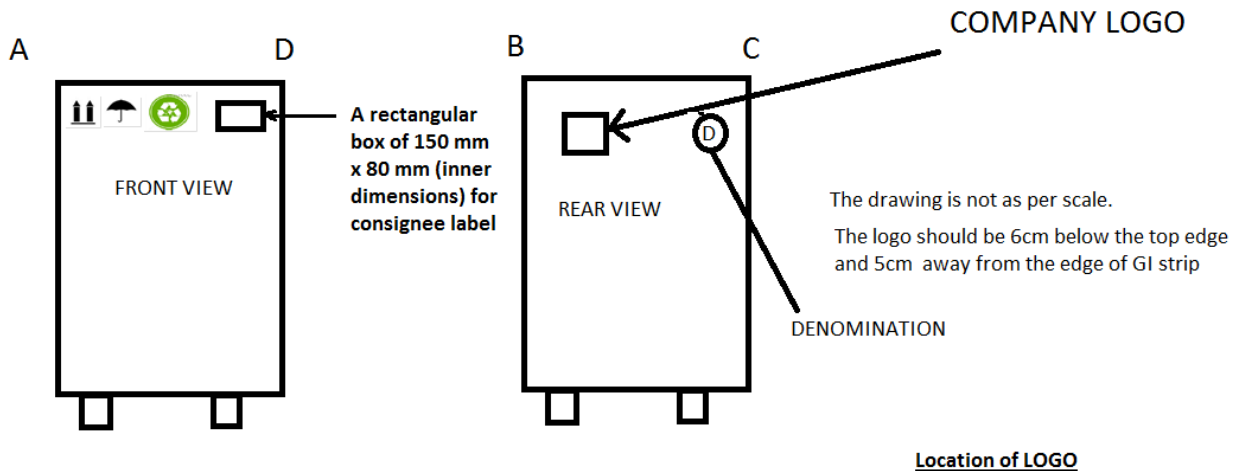
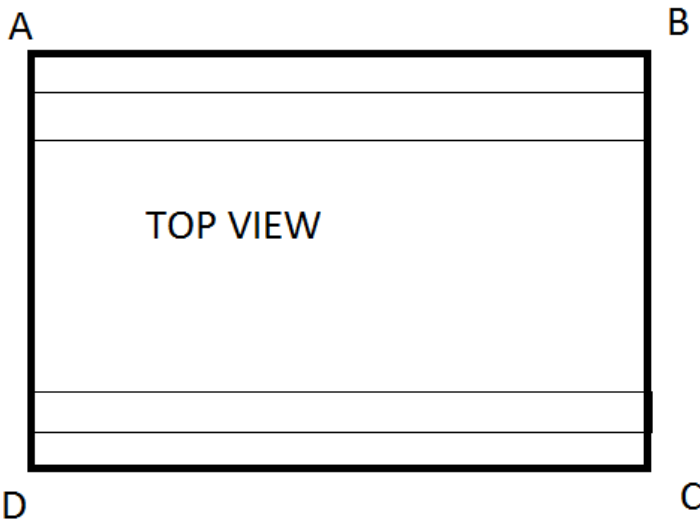

COMMERCIAL COMPLIANCE STATEMENT:

Sl. no.	Features	Requirements of BNPMIPL, Terms & conditions	Whether Agreed by the firm	Deviation, if any
01	General Conditions and list of requirement	Supply/Service shall be rendered exactly as per the given instructions / Scope of work mentioned in Section VII of the tender	Yes agreed	
02	Quantity	As per the technical requirements mentioned in Section VI & VII of the tender.	Yes agreed	
03	Delivery	As per section -VI	Yes agreed	
04	Payment terms	Payment terms as mentioned in Sl No 8 (GCC Clause No 22) of SCC	Yes agreed	
05	Liquidated Damages	As per liquidated damages clause mentioned in Sl No 9 (GCC clause No 24) of SCC	Yes agreed	
06	Performance Security	As mentioned in Sl No 2 (GCC clause No 6) of SCC	Yes agreed	
07	Tender terms & conditions	We have gone through entire tender document thoroughly including GIT (Section II - General Instructions to Tenderer), SIT, GCC (Section IV - GENERAL CONDITIONS OF CONTRACT), SCC <u>and confirm that we don't have any counter conditions.</u> We also understand that offer with counter conditions is liable for rejection	Yes agreed	
08	Compliance to SCC Clauses	As mentioned in Sl.no 13 to Sl.no 19	Yes agreed	
09	No. of pages	Total number of pages in Technical Bid		

Authorized signatory & stamp

(To be signed & stamped and submitted along with Techno-commercial Bid Part -I)

SECTION IX – QUALIFICATION/ ELIGIBILITY CRITERIA

Category	Eligibility Criteria	Documents required in support of eligibility criteria																		
Experience & Past Performance	Individual/ firm/HUF/LLP/ company/ corporate / limited company intending to bid should be bonafide, experienced, technically competent, resourceful and financially sound to carry out the assigned order	Company's registration certificate/Certificate of incorporation/Partnership Deed/Any other registration certificate (as applicable)																		
	Bidders must have supplied Collapsible Plywood Packing Boxes in any one year during the last five years period ending 31.12.2019 as given below:	Purchase Orders/ performance certificate/ work completion certificate indicating a) Name of Work / Order, b) Name of Customer, c) Value of Work, d) Any other information should also be submitted supporting the above information.																		
	<table border="1" style="width: 100%; border-collapse: collapse;"> <thead> <tr> <th style="width: 10%;">Sl No.</th> <th style="width: 20%;">If quoted for</th> <th style="width: 70%;">Supplied qty.</th> </tr> </thead> <tbody> <tr> <td style="text-align: center;">1.</td> <td style="text-align: center;">Schedule-1</td> <td style="text-align: center;">Min. 3600 Set</td> </tr> <tr> <td style="text-align: center;">2.</td> <td style="text-align: center;">Schedule-2</td> <td style="text-align: center;">Min. 675 Set</td> </tr> <tr> <td style="text-align: center;">3.</td> <td style="text-align: center;">Schedule-3</td> <td style="text-align: center;">Min. 1350 Set</td> </tr> <tr> <td style="text-align: center;">4.</td> <td style="text-align: center;">Schedule-4</td> <td style="text-align: center;">Min. 450 Set</td> </tr> <tr> <td style="text-align: center;">5.</td> <td style="text-align: center;">Schedule-5</td> <td style="text-align: center;">Min. 1125 Set</td> </tr> </tbody> </table>		Sl No.	If quoted for	Supplied qty.	1.	Schedule-1	Min. 3600 Set	2.	Schedule-2	Min. 675 Set	3.	Schedule-3	Min. 1350 Set	4.	Schedule-4	Min. 450 Set	5.	Schedule-5	Min. 1125 Set
	Sl No.		If quoted for	Supplied qty.																
	1.		Schedule-1	Min. 3600 Set																
	2.		Schedule-2	Min. 675 Set																
	3.		Schedule-3	Min. 1350 Set																
4.	Schedule-4	Min. 450 Set																		
5.	Schedule-5	Min. 1125 Set																		
If quoting more than one schedule bidders must have supplied collapsible packing boxes cumulative of above quantity.																				
The bidder should be manufacturer of packing boxes.	Registration certificate & Manufacturing facility details in case of OEM.																			
Capacity	The vendor should be capable of supplying a minimum of 60 No. of boxes per day or 1500 sets of boxes per month.																			
Equipment & Manufacturing Facilities and plant assessment criteria	<p>1. Machinery [max. points: 20]: : For quality CPPBs to be manufactured, a series of machinery are required:</p> <ol style="list-style-type: none"> a. <u>Cutting machine</u> b. <u>Chamfering machine</u> c. <u>Hole punching machine</u> d. <u>Hydraulic pressing machine</u> e. <u>Profiling & Bending machine</u> f. <u>V- Cutting machine</u> g. <u>Pneumatic nail gun</u> <p>2. Storage Space [max. points: 10]: Adequate, clean and dedicated storage space is required to prevent the inventory of CPPBs from attracting debris and moisture.</p> <p>3. Tooling (Jigs) [max. points: 10]: In order to maintain dimensional accuracy and consistency between the runners</p>																			

SECTION IX – QUALIFICATION/ ELIGIBILITY CRITERIA

	<p>that are fixed onto the base pallet, proper tooling and jigs are to be used in the process. This will ensure that the runners are equidistant from both ends for all batches of pallets that are manufactured.</p> <p>4. Shop Floor/ Working area [max. points: 05]: Various activities in the manufacturing of CPPBs result in fine dust and small wood chips to settle on the floor, machinery as well as are suspended in the air, making the area difficult and unsafe to work in.</p> <p>5. Defects traceability [max. points: 05]: If a certain number of CPPBs are found to be defective after receiving at site, it should be possible for the supplier to identify the particular batch in which the boxes were manufactured. This is particularly important for identifying defects in the wood and tin sheet.</p> <p>BNPM may verify the bidder's equipment and manufacturing facilities as a prequalification criteria of tender. A combined minimum of 30 points out of a maximum of 50 points are necessary to qualify for opening the price bid (This is applicable for new bidders)</p>													
Financial Standings	<p>Average annual turnover of the bidder firm during last three years ending 31.03.2019 should be as below, if quoted for individual schedule:</p> <table border="1" style="width: 100%; border-collapse: collapse;"> <thead> <tr> <th style="width: 30%;">If quoted for</th> <th>Annual turnover</th> </tr> </thead> <tbody> <tr> <td>Schedule-1</td> <td>Rs.1.37 Cr.</td> </tr> <tr> <td>Schedule-2</td> <td>Rs.25 Lakh</td> </tr> <tr> <td>Schedule-3</td> <td>Rs.50 Lakh</td> </tr> <tr> <td>Schedule-4</td> <td>Rs.16 Lakh</td> </tr> <tr> <td>Schedule-5</td> <td>Rs. 43 Lakh</td> </tr> </tbody> </table> <p>If quoting more than one schedule bidders should have annual turnover cumulative of above value.</p> <p>Bidder Firms should not have suffered any financial loss for more than one year during the last three years ending 31.03.2019</p> <p>The net worth of the firm should not be in negative as on 31.03.2019 and should not have eroded by more than 30% in the last three years ending 31.03.2019.</p> <p>Erosion shall be considered only on account of reported loss in the statement of P&L account, which has led to reduction in capital</p>	If quoted for	Annual turnover	Schedule-1	Rs.1.37 Cr.	Schedule-2	Rs.25 Lakh	Schedule-3	Rs.50 Lakh	Schedule-4	Rs.16 Lakh	Schedule-5	Rs. 43 Lakh	<p>Audited balance sheet and profit & loss statement for FY 2018-19, 2017-18 and 2016-17 to be submitted along with the techno-commercial bid</p> <p>Note: In case of non-availability of audited balance sheet & Profit / (loss) statement for the financial year 2018-19. A provisional balance sheet and Profit / (loss) statement for the financial year 2018-19 duly signed by competent authority shall be submitted.</p>
If quoted for	Annual turnover													
Schedule-1	Rs.1.37 Cr.													
Schedule-2	Rs.25 Lakh													
Schedule-3	Rs.50 Lakh													
Schedule-4	Rs.16 Lakh													
Schedule-5	Rs. 43 Lakh													
General	<p>Bidder should have valid GST registration certificate</p>	<p>Copy of GST certificate (Unregistered/compounding/Registered). If any exemption, relevant document to be submitted along</p>												

SECTION IX – QUALIFICATION/ ELIGIBILITY CRITERIA

		with the techno-commercial bid.
	Bidder should have valid PAN card.	Copy of PAN card to be submitted along with the techno-commercial bid
	The tenderer should have not been blacklisted / debarred by BRBNMPL/ SPMCIL/ BNPMIPL/ Government of India for participating in tender. Annexure-A.	Sealed & signed Annexure –A on company’s letter head to be submitted along with the techno-commercial bid
	The tenderer shall enclose a declaration towards acceptance to GIT, GCC, SIT, SCC duly signed and stamped as per Annexure-B	Sealed & signed Annexure –B on company’s letter head to be submitted along with the techno-commercial bid.

Bidder to furnish stipulated documents in support of fulfillment of qualifying criteria. Non-submission or incomplete submission of documents may lead to rejection of offer.

All experience, past performance and capacity/capability related data should be certified by the authorized signatory of the bidder firm. The credentials regarding experience and past performance to the extent required as per eligibility criteria submitted by bidder may be verified from the parties for whom work has been done.

We confirm that, we are competent and legally authorized to submit the tender and/or to enter into legally binding contract.

We (Name of the company) have submitted the required documents in support of the eligibility criteria mentioned above.

Authorized Signature with stamp & date

(To be signed & stamped and submitted along with Techno-commercial Bid Part –I)

SECTION IX - QUALIFICATION / ELIGIBILITY CRITERIA

ANNEXURE -A

e-Tender No. BNPM/NCB/CPBP/1024/19-20 dated 08.01.2020

(To be submitted on the letterhead)

DECLARATION

We do hereby declare that,

1. We have not been blacklisted/ debarred by BNPMIPL/ BRBNMPL/ SPMCIL or any Govt. Departments. The information provided above is correct and true to the best of my knowledge and belief.
2. The director/proprietor of the bidding firm are not closely related to BNPMIPL.

In case, at any time the information furnished is found to be false, you may disqualify/ debar me/ us as deemed fit.

Signature _____

Name-----

Designation-----

Date-----

Stamp of the Organization-----

SECTION IX – QUALIFICATION / ELIGIBILITY CRITERIA

ANNEXURE -B

e-Tender No. BNPM/NCB/PPP/1024/19-20 dated 10.01.2020

(To be submitted on the letterhead)

DECLARATION

We do hereby declare that we have read and understood all terms and conditions of tender document including GIT, SIT, GCC, SCC, Technical Specification, Quality Control Criteria and confirm to abide to those conditions without any counter conditions.

Signature _____

Name-----

Designation-----

Date-----

Stamp of the Organization-----

SECTION IX - QUALIFICATION / ELIGIBILITY CRITERIA

List of Machinery	Availability (YES/NO)
Cutting machine	
Chamfering machine	
Heat Treatment Chamber	
Hole punching machine	
Hydraulic pressing machine	
Profiling & Bending machine	
V- Cutting machine	
Pneumatic nail gun	
OTHERS IF ANY	

SECTION X – TENDER FORM

(Bidder shall use this covering letter while submitting the offer)

To

Date _____

Bank Note Paper Mill India Private Limited
Administrative Building,
Entry Gate No 1, Paper Mill Compound,
Note Mudran Nagar
Mysuru 570 003
Karnataka

Ref: Your Tender document No. BNPM/NCB/CPPB/1024/19-20 dated 08.01.2020

We, the undersigned have examined the above mentioned tender enquiry document, including amendment No. -----, dated ----- (if any), the receipt of which is hereby confirmed. We now offer to supply and deliver..... (description of goods) in conformity with your above referred document for the sum as shown in the price schedule(s), attached herewith and made part of this tender.

If our tender is accepted, we undertake to supply the goods as mentioned above, in accordance with the delivery schedule specified in the List of Requirements.

We further confirm that, if our tender is accepted, we shall provide you with a performance security of required amount in an acceptable form in terms of GCC clause 6, read with modification, if any, in Section V- "Special Conditions of Contract", for due performance of the contract.

We agree to keep our tender valid for acceptance for a period up to **120days**, as required in the GIT clause 19, read with modification, if any in Section-III -"Special Instructions to Tenderers" or for subsequently extended period, if any, agreed to by us. We also accordingly confirm to abide by this tender up to the aforesaid period and this tender may be accepted any time before the expiry of the aforesaid period. We further confirm that, until a formal contract is executed, this tender read with your written acceptance thereof within the aforesaid period shall constitute a binding contract between us.

We further understand that you are not bound to accept the lowest or any tender you may receive against your above-referred tender enquiry.

(Signature with date)

(Name and designation)

Duly authorized to sign tender for and on behalf of

SECTION XI - PRICE SCHEDULE

(TO BE FILLED ONLINE ONLY THROUGH e-PORTAL)

(A copy of sealed & signed blank price schedule has to be submitted along with pre-qualification & techno-commercial offer)

Dear Sir,

Sub: Price bid for Supply of Collapsible plywood packing boxes at BNPM Plant, Mysuru on annual rate contract.

Ref: e-Tender No. BNPM/NCB/CPPB/1024/19-20 dated 10.01.2020

We have received and understood the above tender enquiry and are pleased to submit our price bid as under:

Schedule No.	Description	UOM	Quantity	HSN /SAC Code	Price for Supply (INR)								
					Basic unit Price (INR)	Freight, P&F & any other charges (INR)	Unit price (Incl. of Freight, P&F) (INR)	GST @ 12% (INR)	Total unit price (Incl. of Freight, Insurance, P&F & GST) (INR)	Input Tax Credit for HSN/SAC (INR)	Effective unit price (net of input tax credit) (INR)	Effective price (net of input tax credit) (INR)	
					(a)	(b)	(c)=(a)+(b)	(d)	(e)=(c)+(d)	(f)	(g)=(e)-(f)	(h)=(g)*(q)	
1.	Collapsible packing boxes (740x820x970)mm	SET	24000										
2.	Collapsible packing boxes (740x800x970)mm	SET	4500										
3.	Collapsible packing boxes (740x780x970)mm	SET	9000										
4.	Collapsible packing boxes (740x740x970)mm	SET	3000										
5.	Collapsible packing boxes (710x840x970)mm	SET	7500										
Total effective price (net of input tax credit) for supply, installation & commissioning of door frame metal detector with GST, freight, Insurance, P&F and any other charges (D.A.P - Mysore site) (INR)													

SECTION XI - PRICE SCHEDULE

The method of evaluation of bidder for awarding the contract shall be on the basis of Schedule /Item wise price quoted by the bidder for delivery up to BNPM, Mysore for that item.

()

Seal

Name

Signature with Date

Note:

- i) Price should be quoted exactly as per the format given above; Price bids with conditions / Counter conditions are liable for rejection.
- ii) Multiple / Variable rate for single item, would lead to rejection of offer.

SECTION XII - QUESTIONNAIRE

The tenderer should furnish specific answers to all the questions/concerns mentioned below. In case a question/concern does not apply to a tenderer, the same should be answered with the remark “not applicable”.

Wherever necessary and applicable, the tenderer shall enclose certified copy as documentary proof/ evidence to substantiate the corresponding statement.

In case a tenderer furnishes a wrong or evasive answer against any of the under mentioned question/ issues, its tender will be liable to be ignored.

S. No.	Description	To be filled by bidder
1	Brief description of goods and services offered	
2	Offer is valid for acceptance up to	
3	Your permanent income tax A/c no. as allotted by the Income Tax Authority of Government of India (Please attach certified copy of your latest/ current Income Tax clearance certificate issued by the above authority)	
4	Are you currently registered with the Directorate General of Supplies & Disposals (DGS&D), New Delhi, and/ or the present BNPMIPL and/ or the Directorate of Industries of the concerned State Government/NSIC/SSI for the goods quoted? If so, indicate the date up to which you are registered and whether there is any monetary limit imposed on your registration.	Yes / No If Yes: Registration No..... Validity:
5	Are you currently registered under the Indian Companies Act, 1956 or any other similar Act? (Please attach certified copy (s) of your registration status etc. in case your answer (s) to above queries is in affirmative	
6	Bank account/NEFT/RTGS details	Name of bank: Branch: A/c No.: IFSC: MICR:
7	Please state whether business dealings with you currently stand suspended/ banned by any Ministry/ Dept. of Government of India or by any State Govt.	

SECTION XII - QUESTIONNAIRE

8	EMD details:	Online/Offline/Exempted/Not Applicable
	a) Online:	NEFT/RTGS Details:_____ Dtd:_____
	b) Exempted:	Whether NSIC/MSE/DGS&D Reg. no:
9	Tender Fee:	Online / Offline
	a) Online:	NEFT/RTGS Details:_____ Dtd:_____
10	We confirm that we possess the necessary technical competence and financial resources as mentioned in Section -IX of this tender document, to ensure supply of the tendered item, as per your specifications and delivery schedule. Necessary documents like copies of Purchase orders, P/L Accounts, Balance Sheets are enclosed	Yes / No
11	We confirm that we have quoted exactly for the tendered product as per your specifications given in Section VII	Yes / No
12	We confirm that the Price bid is quoted exactly as per your format in Section- XI	Yes / No
13	We confirm that there would not be any price escalation (Except Statutory Charges) during the supply / contract period	Yes / No
14	We confirm that we will abide by all the tender terms & conditions and we do not have any counter conditions. As required, we enclose herewith the complete set of copy of tender documents duly signed by us as a token of our acceptance	Yes / No

We also confirm that the undersigned is duly authorized and have the competence to submit the tender and / or to enter into legally binding contract for and on behalf of the firm.

.....

(Signature with date)

(Full name, Designation & address of the person duly authorized sign on behalf of the tenderer)

For and on behalf of

.....

.....

(Name, address and stamp of the tendering firm)

**NOT APPLICABLE TO THIS
TENDER DOCUMENT**

SECTION XIV- MANUFACTURER'S AUTHORIZATION FORM

To

Bank Note Paper Mill India Private Limited
Administrative Building, Entry Gate 1,
Paper Mill Compound, Note Mudran Nagar,
Mysore - 570003

Dear Sirs,

Ref. Your Tender document no. BNPM/NCB/CPB/1024/19-20 dated 10.01.2020

We, _____ who are proven and reputable manufacturers of _____ (name and description of the goods offered in the tender) having factories at _____ hereby authorize Messrs. _____ (name and address of the agent) to submit a tender, process the same further and enter into a contract with you against your requirement as contained in the above referred tender enquiry documents for the above goods manufactured by us.

We further confirm that no supplier or firm or individual other than Messrs. _____ (name and address of the above agent) is authorized to submit a tender, process the same further and enter into a contract with you against your requirement as contained in the above referred tender enquiry documents for the above goods manufactured by us.

We also hereby extend our full warranty, as applicable as per clause 16 of the General Conditions of Contract read with modification, if any, in the Special Conditions of Contract for the goods and services offered for supply by the above firm against this tender document.

Yours faithfully,

[Signature with date, name and designation]

For and on behalf of Messrs.

.....

[Name & address of the manufacturers]

Note: This letter of authorization should be on the letter head of the manufacturing firm and should be signed by a person competent and having the power of attorney to legally bind the manufacturer.

SECTION XV- BANK GUARANTEE FORM FOR PERFORMANCE SECURITY

..... (Insert: Bank's Name, and Address of Issuing Branch or Office)

Beneficiary:

Bank Note Paper Mill India Private Limited
Administrative Building, Entry Gate 1,
Paper Mill Compound, Note Mudran Nagar,
Mysore - 570003
Date:

Performance Guarantee No.:

WHEREAS.....(name and address of the supplier) (hereinafter called "the supplier") has undertaken, in pursuance of LOI (Letter of Intent) no..... dated to supply (description of goods) (herein after called "the contract").

AND WHEREAS it has been stipulated by you in the said LOI that the supplier shall furnish you with a bank guarantee by a scheduled commercial bank recognized by you for the sum specified therein as security for compliance with its obligations in accordance with the LOI;

AND WHEREAS we have agreed to give the supplier such a bank guarantee;

NOW THEREFORE we hereby affirm that we are guarantors and responsible to you, on behalf of the supplier, up to a total of..... (amount of the guarantee in words and figures), and we undertake to pay you, upon your first written demand declaring the supplier to be in default under the contract and without cavil or argument, any sum or sums within the limits of (amount of guarantee) as aforesaid, without your needing to prove or to show grounds or reasons for your demand or the sum specified therein.

We hereby waive the necessity of your demanding the said debt from the supplier before presenting us with the demand. We further agree that no change or addition to or other modification of the terms of the contract to be performed thereunder or of any of the contract documents which may be made between you and the supplier shall in any way release us from any liability under this guarantee and we hereby waive notice of any such change, addition or modification.

We undertake to pay Bank Note Paper Mill India Private Limited up to the above amount upon receipt of its first written demand, without Bank Note Paper Mill India Private Limited having to substantiate its demand.

This guarantee will remain in force for a period of sixty days after the currency of this contract and any demand in respect thereof should reach the Bank not later than the above date.

(Signature of the authorized officer of the Bank)

Name, Authorization/ Signature no. and Designation of the officer

Seal, Name & Address of the Bank and Address of the Branch

SECTION XV- BANK GUARANTEE FORM FOR PERFORMANCE SECURITY

Checklist for Bank Guarantee:

EMD/Performance BG should be in line with/comply the following.

1. BG should be issued on not less than Rs.200 e-stamp/non judicial stamp paper.
2. Non judicial stamp paper/e-stamp paper should be purchased in the name of BG issuing bank only.
3. In case of e-stamp paper first party should be BG issuing bank and second party should be BNPM.
4. Date of sale of non-judicial/e-stamp paper shown on the BG and the stamp paper (BG) issued should not be more than six months prior to the date of execution of BG.
5. Executing officer of BG should indicate his name, designation and power of attorney number / signing power no etc. on each page of BG.
6. Name and address of the bidding party, name and address of BNPM and value of the contract are to be mentioned clearly.
7. Overwriting / cutting if any in BG should be authenticated under signature and seal of authorized signatory of BG issuing Bank.
8. BG number and BG date should be mentioned in all pages of BG and all pages are endorsed / signed by authorized signatories of issuing bank.
9. Amount mentioned in figures and words are to be matched.
10. Validity of BG should be in line with the contract.
11. BG should be unconditional.

**NOT APPLICABLE TO THIS
TENDER DOCUMENT**

**SECTION XVII- LETTER OF AUTHORITY FOR ATTENDING BID
OPENING**

**NOT APPLICABLE TO THIS
TENDER DOCUMENT**

**SECTION XVIII- SHIPPING ARRANGEMENTS FOR LINER
CARGO'S**

**NOT APPLICABLE TO THIS
TENDER DOCUMENT**

SECTION XIX- PROFORMA OF BILLS FOR PAYMENT

**NOT APPLICABLE TO THIS
TENDER DOCUMENT**

**SECTION XX- PROFORMA FOR PRE-CONTRACT INTEGRITY
PACT**

**NOT APPLICABLE TO THIS
TENDER DOCUMENT**